



in conjunction with RADIONAV

MTU





used with RADIONAV

**THE INNOVATIVE TELEMATIC SOLUTION FOR CARS
BASED ON WINDOWS Mobile™**

**HANDS-FREE SYSTEM WITH Bluetooth® TECHNOLOGY,
SMS MESSAGE READER AND MEDIA PLAYER**



page intentionally left blank

<i>General information</i>	1	<i>Media Player functions</i>	9
<i>Display and steering wheel controls</i>	2	<i>Settings functions</i>	10
<i>Hands-free function quick guide</i>	3	<i>Technologies compatible with Blue&Me™</i>	11
<i>SMS message reader quick guide</i>	4	<i>List of voice commands available</i>	12
<i>Media Player quick guide</i>	5	<i>Troubleshooting</i>	13
<i>Using the system</i>	6	<i>Data protection</i>	14
<i>Hands-free functions</i>	7	<i>Warnings on use of the system software</i>	15
<i>SMS message reader functions</i>	8	<i>Index</i>	16

page intentionally left blank



Blue&Me™ based on Windows Mobile™ is a personal telematic system that allows the use of applications for communication and entertainment, expressly designed for use in cars. The system fitted on your vehicle has the following functions: handsfree, SMS message reader (not all mobile phones support this function), multimedia player and navigator. It is also prepared for additional services that will become available over time.

The system (*) makes a whole range of functions available, but remember that:

- not all mobile phones support them fully, such as, for example, listening to an incoming SMS message or automatically downloading your phonebook.
- certain enhancements are required for using an iPod (see the “Compatible USB memory devices” section).

The system, due to its full integration with voice commands, steering wheel controls, **RADIONAV** controls and information on the on-board multifunction display, allows customers with a mobile phone with **Bluetooth®** technology to use it even if it is in a jacket pocket or a bag, without ever taking their hands off the steering wheel. To use the voice commands, the voice recogni-

tion system does not need time to learn your voice. The system is capable of recognising the voice commands given, irrespective of gender, by the tone of voice and intonation of the person giving the instructions. It is also possible to listen to your favourite music saved on a USB device by selecting the tracks and playback method with either the steering wheel buttons or voice commands.

(*) “System” refers to the **Blue&Me™** telematic system used on the car.

HANDS FREE

The basic feature of this function is hands-free telephone communication with voice recognition and **Bluetooth®** technology. This system allows you to make and receive phone calls by using voice commands or the manual controls on the steering wheel in complete safety, freedom and comfort whilst driving, in accordance with the law.

Bluetooth® technology allows you to use your mobile phone through the vehicle’s hands-free system, without the need for wires.

To use the hands-free function, you need a mobile phone with **Bluetooth®**. This function also offers you the possibility of speaking to your phone while driving, even if the phone does not have this feature. You can interact with your mobile phone manually and visually by using the manual controls on the steering wheel and the multi-function display on the control panel.

For more information on which mobile phones are compatible with the system, please refer to the chapter on COMPATIBLE TECHNOLOGIES with the system.

To start using the system’s hands-free function with voice recognition, simply pair your mobile phone with **Bluetooth®** technology on the system.

You need to pair your mobile phone on the system only once.

Note

When pairing a new mobile phone, the system looks within its operating range for a mobile phone with **Bluetooth**® technology. When it finds one, it establishes a connection by using a Personal Identification Number (PIN).

Once the mobile phone has been paired, you can transfer your contacts over to the system, make a phone call by using the phonebook or by saying the telephone number, accept a call and answer a second incoming call.

You can use both the steering wheel controls and voice recognition to interact with the system. With voice recognition, you can activate the system's functions by giving specific voice commands that are recognised by the system. When the system recognises a voice command, it will respond with the appropriate action. Voice recognition is an easy, practical way of using the system.

All functions are accessible via the system's Main Menu. When the car is stationary, you can navigate the menu by using either the steering wheel controls or voice commands.

When the car is moving, you can interact with the system by using the steering wheel controls or voice commands only for functions relating to the telephone (LAST CALLS and PHONEBOOK) and the Media Player. To activate the settings functions whilst driving, only voice commands are available.

The hands-free function allows the following operations to be performed:

- **Calling a contact in your phonebook using voice commands** — you can phone someone in your mobile's phonebook by using your voice. You can also phone someone in your phonebook by selecting them from the names that appear on the control panel display.
(This function requires your phonebook to be copied onto the car's hands-free system).
- **Calling a phone number using voice commands** — you can dial a phone number by saying the digits.
- **Making a phone call to the sender of an SMS message** — you can directly call the phone number of the person who sent your most recent text message or a message received earlier and saved to the system's inbox.

- **Accepting a call** — you can take an incoming call simply by pressing a button on the steering wheel.
- **Teleconferencing** — you can make a phone call to a third person whilst a call is already active (with **Bluetooth**® phones connected that support this functionality).



- **Call alert** – while you are involved in a telephone conversation, you can receive notice of another incoming call, answer the incoming call and switch from one call to the other. (The call alert is supported by only some of the compatible mobile phones).

With the mobile phone in the car, after having paired it on the system, you can make phone calls through voice commands or by using the steering wheel controls. When using the hands-free system, the telephone conversation is broadcast over the vehicle's speakers.

THE SMS MESSAGE READER (Function available only with compatible mobile phones)

The SMS message reader integrated in the system uses voice synthesis technology to automatically read incoming messages on your mobile phone with **Bluetooth®** technology over your vehicle's sound system, and it can even interpret any abbreviations and emoticons in the text message.

The SMS message reader functions are managed through the steering wheel controls or the system voice commands.

The system's SMS message reader allows you to:

- Be informed, by means of an alert on the instrument panel multifunction display, of a new incoming SMS message on your mobile phone with **Bluetooth®** technology, with the number/name of the sender displayed. The system will also suggest reading the message to you.

- Manage the SMS inbox on the mobile phone connected to the system.
- Re-read SMS messages that have already been received and saved.
- Make a voice call to the sender of the SMS messaged, by using the steering wheel controls or voice commands
- Delete individual SMS messages or the entire inbox, by using the steering wheel controls or voice commands.

The system is also capable of recognising and reading any abbreviations and interpreting the most common emoticons (e.g. :-)) will be read as "Smiley") used to date in SMS messages.

THE MEDIA PLAYER

The Media Player allows you to play digital audio stored on a USB device over your car's sound system, simply by connecting it to the car's USB port.

With the Media Player, you can listen to your personal collection of music tracks whilst driving.

- **iPod Reader** — see the “Compatible USB memory devices” section.

With the Media Player, you can:

- **Play digital audio** — you can play all your digital audio files (*.mp3*, *.wma*, *.aac*, *.wav*) or a personal playlist (in *.m3u* or *.wpl* format).
- **Select audio by category** — you can play all digital audio that belongs to a certain category, for example an album, an artist or a music genre.
- **Use playback functions** — whilst playing tracks, you can use functions such as Play, Stop, Next track, Previous track, Shuffle and Track loop.

Note

The Media Player does not support compressed audio files with other formats and DRM (Digital Right Management) protected audio files or MP4. If there are unsupported audio files on the USB device, they will be ignored.

To use the Media Player, simply connect your USB device (directly or with an extension) to the USB port in the vehicle. When the ignition key is turned to the MAR position, the system will start to create an index of your multimedia library. At the end of the operation, you can navigate around the whole library and browse categories by using the steering wheel controls, voice commands or stereo controls. After you have chosen what you want to listen to, the system will play it through the car's audio system.



ROAD SAFETY



The use of several of the system functions whilst driving can distract attention away from the road with the risk of causing an accident or other serious consequences; they should therefore be used only when driving conditions permit and, if necessary, only with the car stationary.



***Read these instructions and follow them:** before using your system, read and follow all the instructions and safety information in this manual ("User Guide"). Failure to observe the precautions contained in the User Guide may cause accidents or have other serious consequences.*

***Keep the manual in the car:** if it is kept in the car, the User Guide will be quick and easy to consult for those not familiar with the system. Make sure that, before using the system, anyone who has access to the User Guide reads the instructions and the safety information carefully.*

***WARNING** Looking at the system when driving can divert attention from the road, with the risk of accidents or other serious consequences. When driving, do not change the system settings or enter data by using the manual controls. Before carrying out these operations, stop the car safely in accordance with the highway code. Adopting these precautions is important since setting or changing some functions may require drivers to take their eyes off the road and remove their hands from the steering wheel.*



GENERAL OPERATION

Voice commands: the system functions can be carried out using only voice commands. The use of voice commands when driving allows you to manage the system without taking your hands off the steering wheel.

Looking at the display for a long time: while driving, do not use any function that requires looking at the display for a long time. Stop the car safely in accordance with the highway code before consulting any of the system functions that require such attention. Even occasional quick glances at the display can be dangerous if the driver's attention is diverted at a critical moment.

Setting the volume: do not turn the volume up too high. When driving, keep the volume at a level that allows you to hear the traffic outside and emergency sirens. Driving without being able to hear these can cause accidents.

Using the voice recognition: the voice recognition software is based on a statistical process that is subject to error. It is your responsibility to monitor the system's voice recognition functions and to correct any errors.

Danger of distraction: the functions may require manual settings (not using voice commands). Performing these settings or entering data when driving can distract you significantly, causing accidents or having other serious consequences. Before carrying out these operations, stop the car safely in accordance with the highway code.

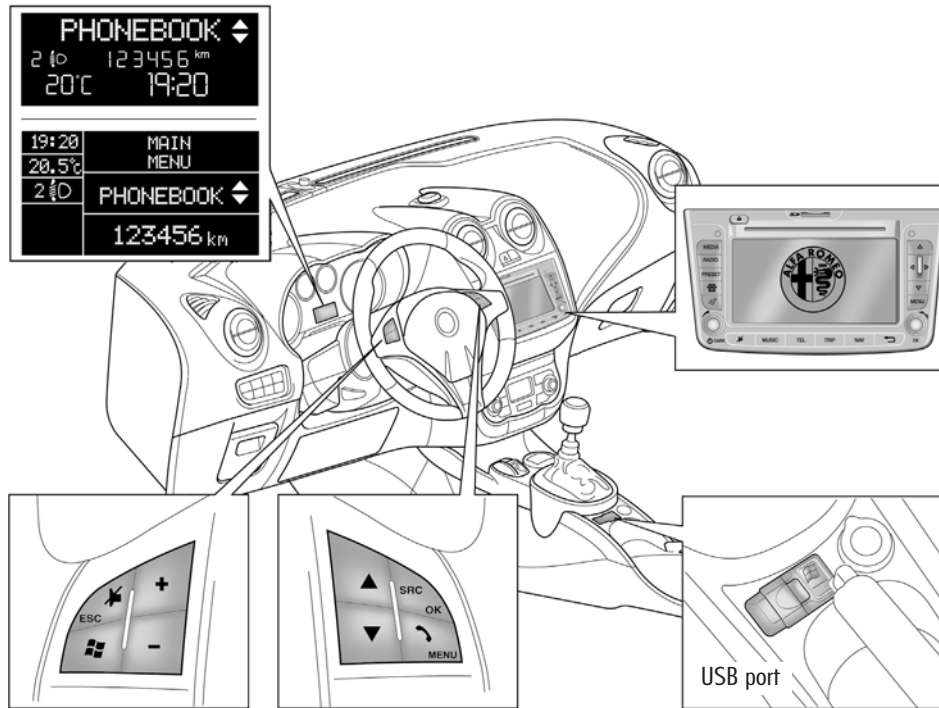





fig. 1

A011184g

In this manual, the descriptions of the menu items refer to the multifunction display, which abbreviates some things compared with the reconfigurable multifunction display. The reconfigurable multifunction display shows the menu items written out in full.

STEERING WHEEL CONTROLS

Button	Short press (less than one second)	Hold down (more than one second)
 /MENU	<ul style="list-style-type: none"> – Activate the system's Main Menu – Confirm the selected menu option – Accept an incoming call – Change from one telephone conversation to another in second-call mode (call alert) – Select the message displayed 	<ul style="list-style-type: none"> – Refuse incoming phone call – End a call
 /ESC	<ul style="list-style-type: none"> – Deactivate voice recognition – Interrupt a voice message – Interrupt the reading of an SMS message – Exit from the system's Main Menu – Exit a sub-menu and return to the previous menu option – Exit the current selection without saving – Deactivate/reactivate the microphone during a phone conversation – Mute the ringtone for an incoming phone call – Activate/deactivate the audio function 	–
	<ul style="list-style-type: none"> – Activate the voice recognition – Interrupt a voice message so you can give a new voice command 	<ul style="list-style-type: none"> – Repeat the last voice message played by the system
+/-	<ul style="list-style-type: none"> – Adjust the audio volume for system functions: hands-free, SMS message reader, multimedia player, voice announcements 	–

Note

- For many functions, the **SRC/OK** and **\ /MENU** steering wheel controls are interchangeable and you can select the button you prefer.
- For both methods of operating the steering wheel controls (short press or hold down), the function is activated when you release the button.



Button	Short press (less than one second)	Hold down (more than one second)
▲/▼	<ul style="list-style-type: none"> – Scroll through system menu items – Select Media Player tracks – Scroll SMS messages in the inbox 	–
SRC/OK	<ul style="list-style-type: none"> – Confirm selected menu option during manual operation – Transfer a telephone conversation from the hands-free system to the mobile phone and vice versa – Select audio source (Radio, CD, Media Player) – Select the SMS message displayed 	–

RADIONAV COMMANDS

Button	Short press (less than one second)	Hold down (more than one second)
▲▼	– Select previous/next folder/artist/genre/album depending on the selection mode enabled	–
◀▶	– Play previous/next track	–
🔇	<ul style="list-style-type: none"> – Mute the ringtone for an incoming phone call – Activate/deactivate the audio function 	–
TEL	– Access the call information screen	–
MEDIA	– Select audio source (CD and Media Player)	–

Note

- For many functions, the **SRC/OK** and **↖/MENU** steering wheel controls are interchangeable and you can select the button you prefer.
- For both methods of operating the steering wheel controls (short press or hold down), the function is activated when you release the button.

page intentionally left blank



To start using the system's hands-free function with voice recognition and **Bluetooth®** technology:

- Prepare the phonebook on your mobile phone
- Make sure you turn the ignition key to MAR.
- Practise the voice commands
- Pair your mobile phone
- Make a call.
- ➔ The instructions for each of these functions are given in the sections that follow.

PREPARE THE PHONEBOOK ON YOUR MOBILE PHONE

Before pairing your mobile phone on the system, you must make sure you have stored your contacts in the phonebook on your mobile so that you can call them using the car's hands-free system.

➔ If your phonebook does not contain any names, enter new names for the phone numbers that you call most often. For further information on this operation, consult your mobile phone manual.

➔ For the best use of the car's hands-free system, refer to the suggestions on how to store the names in your mobile's phonebook in the chapter MOBILE PHONE PAIRING – SETTINGS FUNCTIONS.



WARNINGS

- Access to the phonebook copied onto the system is possible only when the mobile phone from which it has been copied is connected.
- The names stored on the SIM card or in your mobile phone memory can be transferred onto the system in different ways, depending on the model of mobile phone.

KNOWING THE VOICE COMMANDS

When talking to the system, you can always use the voice command “Help” to obtain detailed instructions on the voice commands available for each interactive stage.

To use the “Help” command, proceed as follows:

- Press the  steering wheel control.
- After the system has given an audible signal to indicate that the voice recognition is activated, say “Help”. The system will give the list of voice commands available.
- At the end of the help message, say “Settings” and, at the end of the message, “Help”. The system will give the list of voice commands available for the Settings menu.
- You can then give one of the available commands and proceed with the dialogue as you wish.
- If you need more help, press  and say “Help”.



PAIRING YOUR MOBILE PHONE

IMPORTANT This operation should be carried out only with the car stationary.

To pair your mobile phone, proceed as follows:

- Press  and say “Settings” and then, at the end of the message from the system, say “Pairing”.
- On the instrument panel multifunction display, the system shows the code number (PIN) to be used for pairing. For the next two stages, consult the chapters in your mobile phone manual on pairing and connecting via **Bluetooth**[®] technology.
- On your mobile phone, look for devices with **Bluetooth**[®] technology (the setting on your mobile phone may be called Search or Add Device, for example). On this list, find “**Blue&Me**” (the name that identifies your car’s system) and select it.

- When prompted, enter the PIN displayed on the instrument panel using your mobile phone keypad. If the pairing is successful, the system will say “Connecting” and at the end the display will show, as confirmation, details of the mobile phone paired.

It is important to wait for this confirmation message; if you press /MENU or /ESC before this message appears, you risk cancelling the pairing process. If the pairing fails, an error message will appear; in this case, you will need to repeat the procedure.

- After pairing your mobile phone, the first time you connect, the system will say “Welcome”. During subsequent pairing procedures or connections with the same telephone, this message will no longer be given.



- The system will ask you if you want to copy the phonebook of the mobile phone you have just paired. Copying the phonebook is recommended. To proceed with the copying, say “Yes”. If you do not want to copy the phonebook, say “No”.
- On some compatible mobile phones, the names in the phonebook are not copied automatically but have to be transferred using the mobile phone keypad. If the system asks you, carry out this procedure following the specific instructions on your mobile phone and press **\ /MENU** when you have finished.

MAKING A CALL

Imagine that Mark is one of the names saved in your phonebook.



To call Mark, proceed as follows:

- Press the  steering wheel control and say “Call Mark”.
- If the system recognises the name Mark, it will show the information relating to this name on the display.

If your phonebook has only one number stored for Mark, the system will ask you directly if you want to call him. To make the call, say “Yes”; otherwise, say “No”.

If you have several telephone numbers for Mark, the system will ask you which phone address you wish to call (for example, “Call Mark work or home?”). Respond by indicating the type of telephone number desired (for example, “Home”).

If you have several telephone numbers for Mark, but there is no indication of the type of number, the system will show the name together with the list of telephone numbers on the display. The hands-free system will ask you if you want to call the telephone number displayed. If the number displayed is the one you wish to call, say “Yes”; otherwise, say “No”. If the person displayed is the one you wish to contact but the number is incorrect, say “Forward” or “Back” to see the other phone numbers available for this person.

To call the number displayed, say “Call”. You can also navigate through this list manually by pressing the  or  steering wheel controls until you find the number you want. At this point, press **\ /MENU** or **SRC/OK** to make the call.

- To end the call, press **\ /MENU** for more than one second.
- ➔ If you have difficulty using the vehicle’s hands-free system, consult the TROUBLESHOOTING — HANDS FREE chapter.

page intentionally left blank



If your **Bluetooth**® phone supports this function, when you receive a new SMS message, the system will notify you through an audible signal and ask if you want to read it.

- Say “Yes” or press the ↵/**MENU** or **SRC/OK** button, and the system will read the last message received
- Say “No” or press the ↵/**ESC** button, and the system will store the message for you to read another time.

To get to know all the functions and ways of using the SMS message reader, refer to the “SMS MESSAGE READER FUNCTIONS” chapter.

➡ If you have difficulty using the vehicle’s SMS message reader, consult the TROUBLESHOOTING — SMS MESSAGE READER chapter.

page intentionally left blank



To start playing the digital audio stored on your USB device, proceed as follows:

- Copy the tracks on your USB device (the system recognises the following formats: *.wma*, *.mp3*, *.wav*, *.aac* for audio files and *.wpl* and *.m3u* for playlists).
- For USB devices without a USB cable, simply connect the device to the USB port in the car (directly or with the help of an extension) (see fig. 1).
- For USB devices with a cable, connect one end to your USB device and the other to the USB port in the car (see fig. 1).
- Turn the ignition key to MAR. The system will automatically start playing your digital tracks (if the AUTOPLAY option is activated), selecting them from a library that is created when the USB device is connected.
- After the system has created a library of your digital audio files, you can select and listen to tracks, albums, artists and playlists by interacting manually or vocally with the system. If your USB device contains a lot of files, creating the library can take a few minutes.
- iPod Reader — see the “Compatible USB memory devices” chapter.
- You can decide whether the playing of the audio files should start automatically when the USB device is inserted or whether it should start only when you give the command.

To get to know all the functions and ways of using the Media Player, refer to the MEDIA PLAYER FUNCTIONS chapter.

➡ If you have difficulty using the Media Player, consult the TROUBLESHOOTING — MEDIA PLAYER chapter.

page intentionally left blank



STEERING WHEEL CONTROLS

The steering wheel controls (see fig.1) enable you to use the hands-free function, activate voice recognition, use the Media Player functions or select an option from the system Menu.

Some commands have different functions depending on the status of the system at a given moment.

The function selected in response to the pressing of a button depends, in some cases, on how long the button is held down for.

➔ DISPLAY AND STEERING WHEEL CONTROLS.

Note

Instructions on using the system through manual controls are shown in the text by the symbol .

RADIONAV COMMANDS

On the front of the **RADIONAV** are the ▲/▼/◀/▶ buttons which, in Media Player mode, allow you to:

- ▲ ▼ Select previous/next folder/artist/genre/album depending on the selection mode enabled
- ◀ ▶ Play previous/next track

VOICE COMMANDS

You do not need to alter your normal driving position for your voice commands to be recognised by the system. The microphone is in the correct position for this purpose.

The words that are recognised by the system are identified as voice commands.

The hands-free system recognises and responds to a predefined list of voice commands. The list of voice commands available depends on the point you are at in the hands-free system menu. The list of voice commands available at any time can always be accessed by pressing  and saying "Help" or by saying "Help" after a system message. The system also recognises personalised voice commands, such as, for example, the names in your phonebook.

To use the voice commands, the voice recognition system does not need time to learn your voice.

To give the system a voice command, press  and wait for the audible signal indicating that the voice recognition system is activated; you can now give the command in your normal voice — not too quickly, but without hesitation. When the system recognises the command, it will respond or perform an action.

The voice commands are divided into level 1, level 2 and level 3.



When a valid* level 1 voice command is given, the system is prepared to recognise level 2 voice commands; when a valid level 2 voice command is given, the system is activated to recognise level 3 voice commands.



If the user gives a valid* level 1 voice command, the sub-menu for that command remains activated until a voice command that leads to another level is given or the interaction is interrupted; the same rule is valid for the lower levels (2 and 3).

➔ For a list of all the available voice commands, refer to the LIST OF AVAILABLE VOICE COMMANDS chapter.

To listen again to the last message given by the system, press  for more than one second or briefly press  and say “Repeat”.

It is possible that the hands-free system will provide spoken information.

A voice announcement is a voice message spoken directly by the system. To end a voice announcement, press /ESC or press  and say “Cancel”.

A voice interaction is an exchange of communications/commands between the hands-free system and the user. To start a voice interaction, press  and give a command. To stop an interaction and start a new one, press  at any time during the interaction and give a voice command.

To end an interaction, press /ESC. You will hear a signal indicating that voice recognition has been deactivated.

At any time, the help function can provide you with a list of commands available at the level where you find yourself. To use the help system, say “Help”, listen to the list of commands available and decide which command you want to give the system.

Adjust the volume to the level that is best for you with the vehicle in motion. To adjust the preset system volume, refer to “EXTERNAL AUDIO Function” chapter in the **RADIONAV** instruction manual. To temporarily adjust the volume of a call in progress, press + or – or turn the **RADIONAV** knob. At the end of the call, the volume will return to its original level.



You can also press + or – to adjust the volume of a voice announcement whilst it is being given by the system.

* Valid means that the voice command is part of the system vocabulary and therefore recognisable at a given level.





Remember that to interrupt a voice announcement, you can press  at any time during a voice interaction and give a new voice command.

Notes

- The instructions for using the system via the voice commands are shown by the symbol .
- After having pressed , if you do not give a voice command within a few seconds the system will ask you to do so. If you do not respond, voice recognition is deactivated. This also happens if you do not provide a response to a question from the system. In these cases, you will hear a signal indicating that voice recognition has been deactivated.
- When the system does not manage to recognise your voice command, it will give you another chance to give the command. If you are not sure that the voice command is correct on a given level, say "Help".

Using voice recognition

The voice recognition system can sometimes make a mistake when recognising a voice command. To make sure you that your voice commands are always recognised, use the following guidelines:

- After having pressed , give the voice command after the system has provided the audible signal that indicates that the voice recognition is activated.
- After the system has asked you a question, wait a second before giving the answer, in order to be sure that voice recognition is on.
- If you want to give a command without waiting for the system to finish its message or question, you can briefly press the  button again to interrupt the system and give your command.
- Speak at a normal volume.
- Say the words clearly, not too quickly but without hesitation.

- If possible, try and keep the noise in the passenger compartment to a minimum.
- Before giving voice commands, ask your passengers not to speak. Since the system recognises the words regardless of who speaks, if several people speak at the same time, the system may pick up different or additional words to those that you have said.
- For optimum operation, it is advisable to close the sunroof if your vehicle has one.

Notes

For countries where a mother-tongue version is not available, voice recognition of the commands and especially the phonebook contacts could be difficult. We advise adopting pronunciation that conforms to the language in the system.

To change the voice recognition language, go to an Alfa Romeo Dealership or consult the dedicated section at www.alfaromeo.com.

DISPLAY

Various functions are shown on the instrument panel and **RADIONAV** displays (see fig. 1).

Different types of information are shown on the instrument panel display (fig. 2 and fig. 3):

- Information on the status of the mobile phone connected via **Bluetooth**® technology:



fig. 2

A011018g

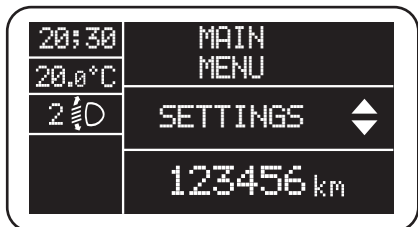

fig. 3

A011050g

- indicates that the system is connected to a mobile phone with **Bluetooth**® technology
 - NO BLUETOOTH — indicates that the connection with the mobile phone is broken (versions with multifunction display)
 - If there is no symbol, this indicates that the connection with the mobile phone is broken (versions with reconfigurable multifunction display).
 - The symbol indicates that the active call is the first one answered; this symbol is present only in the case of call waiting (versions with reconfigurable multifunction display).
 - The symbol indicates that the active call is the second one answered; this symbol is present only in the case of call waiting (versions with reconfigurable multifunction display).
 - The symbol means that a Telephone Conference is activated (versions with reconfigurable multifunction display).
 - Name of the telephone operator active on your mobile phone (if not available, "----" is displayed)
 - Information relating to an SMS message having been received, the telephone number or the contact name (if stored in the phonebook) of the SMS message sender.
 - Information relating to the system function activated or the menu option selected (see figs. 2 and 3).
 - The information shown on the **RA-DIONAV** display relates to:
 - the TEL function
 - calls received/made (only if the Privacy function is disabled)
 - audio tracks
 - the Media Player settings.
- ➔ For further information, please see the **RADIONAV** manual.



AUDIO

The system audio (hands free, Media Player, voice announcements, audible signals) is played over your car's sound system. For this reason, any active **RADIONAV** audio source is paused for the necessary time.

You can always adjust audio volume by using the **RADIONAV** commands.

SYSTEM FUNCTIONS MENU

The system Main Menu shows the options in a list which is shown on the control panel multifunction display. The system settings can be changed or the functions activated using the available options.

Note

The settings menu can be navigated by using the steering wheel controls only when the car is stationary.

The Main Menu includes the following options:

- LAST CALLS. — a list of recent calls, made or received, can be viewed through this sub-menu. This list is either downloaded from your mobile phone's memory, updated during hands-free use or obtained from both operations.
- PHONEBOOK — this sub-menu allows you to view the numbers in your phonebook and select one to make a call. If your phonebook contains a lot of names, they will be grouped in alphabetical sub-menus. The amount of phone numbers contained in a sub-menu depends on the number of names in your phonebook.
- SMS MESSAGE READER (Function available only with compatible mobile phones). This sub-menu allows you to read the last SMS message received, call the sender of the message or delete it. You can store up to 20 SMS messages in a dedicated list and listen to them later, call the sender or delete them. You can also set the notification methods for received SMS messages.
- MEDIA PLAYER — this sub-menu allows you to select the digital audio tracks in your library by folder, artist, genre, album or playlist. This sub-menu can also be used to access the Media Player settings iPod READER — see the "Compatible USB memory devices" paragraph.
- SETTINGS — this sub-menu allows you to manage the names in your phonebook, pair a new device or access the identification code for the hands-free system.

Launching the Main Menu

To activate the system Main Menu, press **↖/MENU**, after which you can start to interact with the system by using the steering wheel controls.

Navigation via the menu options

To navigate through menu items, press **▲** or **▼**.

In the display of contact names, if the number of characters exceeds the maximum allowed, the name is truncated.

To select the option shown on the display, press **SRC/OK** or **↖/MENU**.

To exit an item shown on the display or a sub-menu, press **↵/ESC**.

RADIONAV FUNCTIONS MENU

○ MEDIA PLAYER

Select the “MEDIA PLAYER” source and press **MUSIC** to access the information screen. Press **OK** to access the Media Player menu, select the item desired by twisting the **OK** knob and press once again to confirm the choice.

○ TEL

Press the **TEL** button to access the information screen, press the **OK** knob to access the **TEL** menu, select the desired item by turning the knob and press it again to confirm the selection.

➡ For further information, please see the **RADIONAV** manual.



The system allows you to make and receive calls using your mobile phone equipped with **Bluetooth®** technology, by using voice recognition or steering wheel controls.

You can use voice commands to phone your contacts by saying their name and/or surname, or you can phone numbers that are not stored, by saying the number out loud, or you can call the sender of a received SMS message.

Using the steering wheel controls, you can call your contacts or bring up a list of calls that you have made or received, by selecting the desired name from the LAST CALLS or PHONEBOOK sub-menus.

Furthermore, you can respond to incoming calls, redial an engaged number, receive a call alert, read an SMS message or delete it.

➔ If you have any difficulties using the telephone functions through the vehicle's hands-free system, see the TROUBLESHOOTING — HANDS FREE section.

Notes

- Before you can make and receive calls using the hands-free system, you must register your mobile phone in the system.
- ➔ SETTINGS FUNCTIONS — REGISTERING YOUR MOBILE PHONE
- To activate the car's hands-free system, the ignition key must be in the MAR position.
- If you turn the ignition key to the STOP position during a phone conversation, you can continue the conversation for another 15 minutes via the hands-free system.

MAKING A CALL

A call can be made in one of the following ways:

- Call a contact in your phonebook
- Call a number using voice commands
- Call a number using the mobile phone keypad
- Call a number in the call log
- Call the sender of an SMS message received
- ➔ For further information, refer to the SMS MESSAGE READER FUNCTIONS — MANAGING SMS MESSAGES section.

Call a contact in your phonebook

To use this mode, you need to register your phone and copy your contacts across to the system.

 To call someone from your phonebook using manual controls, proceed as follows:

Activate the Main Menu by pressing **\ /MENU**.

Select the option PHONEBOOK and then press **SRC/OK** or **\ /MENU**.

Press **▲** or **▼** to select the alphabetic group to which the name of the person to contact belongs, press **SRC/OK** or **\ /MENU** and then select the desired name.

If there is only one phone number for the person you wish to contact, press **SRC/OK** or **\ /MENU** to make the call.

If there are several phone numbers for the person you wish to contact, press **SRC/OK** or **\ /MENU** to access the different contact numbers, then select the one you wish to contact by using **▲** or **▼** and press **SRC/OK** or **\ /MENU** to make the call.

To end the call, press **\ /MENU** for more than one second.

 Or, with voice interaction: Imagine you want to call someone named Mark who features in your mobile phone contacts.

Press **⊞** and say "Call Mark" or "Call Mark mobile" (in the voice command, the word "mobile" represents the specific number you wish to call. You can also use the words "home", "work" or "other").

If the name is recognised, the system will display the information relating to the name (Mark, in this instance).

If the contact person has only one phone number, the hands-free system will ask you if you want call it. To make the call, say "Yes"; otherwise, say "No".

If the contact person has more than one phone number, the system will ask what kind of phone number to dial (for example, "Call Mark work or home?"). In this case, respond by indicating the type of telephone number desired (for example, "Home").

If the contact person (Mark) has more than one telephone number without an indication of the type of number, the system will display the name and a list of phone numbers.

If you want to call the number displayed, say "Call".

If the name recognised by the system is correct, but the number is not the one you want, you can see the other phone numbers available from the list on the display by using the **▲** or **▼** buttons. When you have identified the number you want, press **\ /MENU** or **SRC/OK** to make the call.

To end the call, press **\ /MENU** for more than one second.



Suggestion

When you call a contact with more than one telephone number, also indicate in the voice command the type of number (“Home”, “Work”, “Mobile”) you wish to call; in this way, you can reduce the number of steps required to make the call.

Call a number using voice commands

To dial a phone number using voice interaction, proceed as follows:

Press  and say “Call number”. The system will respond with “The number, please”.

Say the phone number as a sequence of individual numbers (for example, “0”, “1”, “2”, “3”, “4”, “5”, “6”, “7”, “8”, “9”, “+” (plus), “#” (hash) or “*” (star)).

For example, 0113290103 is pronounced “zero, one, one, three, two, nine, zero, one, zero, three”.

The system will display and vocally repeat the number. If the number is correct, say “Call”. If the number is incomplete, say the missing digits and at the end say “Call”. The system will make the phone call to the number displayed.

To end the call, press /MENU for more than one second.

You can say the phone number in groups of digits; this will allow you to check the correctness of one group of digits at a time. The groups of digits are created from the pauses that you make while saying the number. If you pause after saying a certain number of digits, a group is created. The system will repeat the numbers as it heard them.

If the digits are said correctly, you can continue to dictate the phone number. If they are incorrect, you can delete the group of digits by saying “Delete”. The system will cancel the last group of digits and will display the partially dialled phone number. You can then say the phone number’s remaining digits.

To cancel the dialling of the telephone number, say “Cancel”.

To cancel the entire number and redial, say “Restart”. To ask the system to repeat the phone number recognised, say “Repeat”. If no phone number has been dialled, the system will say “No number available”.

If the telephone number repeated is correct, say “Call” to make the call.

Note

When dialling a number by voice commands, it is important that the noise inside the passenger compartment is reduced as much as possible and that your passengers do not speak while you dictate the number to the system. The voice recognition works regardless of who is speaking. Because of this, if several people talk during this operation, there is a risk that some numbers will be recognised in the wrong way, while others will be added to the desired one or not recognised at all.

Call a number using the mobile phone keypad

 With this system you can dial a phone number using your mobile phone keypad and then hold the conversation using the hands-free system.

To carry out this operation, the telephone must be registered and within the operating range of your vehicle's hands-free system.

To dial a number using the mobile phone keypad, proceed as follows:

- Dial the telephone number using your mobile phone keypad and make the call as normal on your mobile phone.
- Have a phone conversation using the hands-free system.
- To end the call, press **↵/MENU** for more than one second or use the dedicated controls for your mobile phone.

Call a number in the call log

The **LAST CALLS** option is a list of numbers relating to phone calls made and received. It may contain a maximum of 10 received calls, 10 outgoing calls and five missed calls.

 To dial a phone number manually, proceed as follows:

- Activate the Main Menu by pressing **↵/MENU**.
- Select the Last calls option and then press **SRC/OK** or **↵/MENU**.
- The system will give a list of telephone numbers. Use **▲** or **▼** to select the desired phone number; press **SRC/OK** or **↵/MENU** to make the call.
- When you have finished, press **↵/MENU** for more than one second to end the call.

 Or, with voice interaction:

To call back the last person who phoned you, press **☐** and say "Call back". The display will show the information available on the last person who contacted you and the system will ask you if you want to call them. To make the call, say "Yes"; otherwise, say "No".

If you want to call the last person you contacted again, say "Redial". In this case, the system will display the information available on the last person you phoned and will ask you if you want to call them. To make the call, say "Yes"; otherwise, say "No".

It is also possible to use the "Re-call" command. In this case, the system will ask "Redial or call back?". To call back the last person you phoned, say "Redial". To call back the last person who phoned you, say "Call back".



MANAGING AN INCOMING CALL

With the hands-free function, you can respond to incoming calls by using the steering wheel controls. When a call is received, the system will display the caller's ID, where available. The incoming call is signalled by the personalised ring tones of your mobile phone (the availability of this function depends on the specification of your phone).

Answer a call

- To answer a phone call, press **\ /MENU** or select the corresponding item from the TEL menu on the **RADIONAV**.
- To end a call, press **\ /MENU** for more than one second or select the corresponding item from the TEL menu on the **RADIONAV**.

Reject a call

- To reject a call, press **\ /MENU** for more than one second.

Ignore a call

- To ignore a phone call and mute the ring tone, press **\ /MENU** or press **▶** on the **RADIONAV**.

Answering an incoming call during a conversation

To answer an incoming call whilst another phone conversation is in progress, press **\ /MENU**. The system will switch to the incoming phone call and will put the current conversation on hold.

Note

On some mobile phones, you can transfer the ring tones assigned to your contacts to the hands-free system. In this case, the system signals incoming calls by using your mobile phone's personalised ringtones.

MANAGING AN ONGOING CALL

Transferring a call from your mobile phone to the hands-free system

If you are speaking on your mobile phone and get into the vehicle, you can transfer the conversation from your mobile to your vehicle's hands-free system.

Proceed as follows:

- Get into the car and turn the ignition key to the MAR position to activate the hands-free system.
- The system will let the phone know when it is ready to activate hands free.
- To transfer the conversation to hands free, follow the normal procedure for your mobile phone (the procedure will depend on the type of phone).
- The phone conversation will be transferred to the car's hands-free system.

Transferring a call from the hands-free system to your mobile

To transfer a phone conversation from the hands-free system to your mobile phone, press **SRC/OK** or select the corresponding item in the **RADIONAV TEL** menu.

You can talk on your mobile and continue to use the steering wheel controls.

If there is more than one active conversation, you can press **\ /MENU** to move from one phone call to another or select the corresponding item in the **RADIONAV TEL** menu.

Putting the ongoing call on hold

To put an ongoing call on hold and disable the microphone in order to be able to talk without being heard by the other person, press ***/ESC** or select the corresponding item from the **RADIONAV TEL** menu.

TELEPHONE CONFERENCE FUNCTION (only for phones with Bluetooth® technology that support this functionality)

The conference call function allows you to make a phone call to a third person during an active call. You can speak to both people at the same time.

To activate a conference, make the new phone call whilst you already have a call in progress, following the procedure described in the **MAKING A CALL** section.

When the conference call function is activated, the control panel display will show "CONFERENCE" and the symbol  will appear on the **RADIONAV** display.

Once the conference is activated, holding down the **\ /MENU** button or selecting the corresponding item in the **RADIONAV TEL** menu will end both calls.



If your mobile phone with **Bluetooth**® technology supports the SMS message reading function, when a new SMS message is received, the system will notify you through an audible signal and ask if you want to read it (depending on the notification options set).

To consult the list of mobile phones and functions supported go to the dedicated **Blue&Me™** chapter at www.alfaromeo.com or call customer services on 00800.2532.0000.

➔ For information on the signal options, refer to the chapter on signal settings.

 If you want the system to read the SMS message received press **SRC/OK** or **\ /MENU**. The SMS message will be read taking into account any abbreviations and emoticons within the text.

If you do not want to read the SMS message, press **▶/ESC**. The system will not read the message, but will save it so that it can be read another time (for further information, refer to the Read last message received paragraph).

 Or, with voice interaction:

if you say “Yes”, the system will read the message, taking into account any abbreviations. If you do not want to read the message, simply say “No” and the system will save it so you can read it another time (for further information, refer to the Read last message received paragraph).

READING LAST MESSAGE RECEIVED

When an SMS message is received, whether it is read or not, the system will save it to an inbox (refer to the Inbox section).

 If you want to read the last message received, activate the Main Menu and select the option **MESS. READER**, then press **SRC/OK** or **\ /MENU**.

Select the **READ LAST** option and press **SRC/OK** or **\ /MENU**; the system will read the last message received.

 Or, with voice interaction:

Press  and say “Read last”; the system will read the last message received.

INBOX

The system stores up to 20 messages received (if there are concatenated messages, this number may be lower) whilst connected to your **Bluetooth**® mobile phone. When the inbox is full, receipt of a new message involves deleting the oldest message even if it has not been read yet. The messages in the inbox can be deleted individually or all together (refer to the Managing SMS messages section).

 If you want to read a particular saved message, activate the system's Main Menu and select the option MESS. READER, then press **SRC/OK** or **\ /MENU**.

Select the option INBOX and then press **SRC/OK** or **\ /MENU**. Scroll through the saved messages until you reach the one you want; the system will display information on the identity of the sender of the message, where available. Select READ and press **SRC/OK** or **\ /MENU**; the system will read the SMS message selected.

 Or, with voice interaction:

Press  and say "Message reader". After the audible signal, say "Inbox"; the system will display information relating to the first message in the inbox (if present in the phonebook, the number of the sender of the SMS message will be shown).

It is possible to scroll through the inbox by saying "Previous" or "Next"; when the message you want is displayed, say "Read" and the system will read the message selected.

If you say "Delete", the system will delete the message selected.

MANAGING SMS MESSAGES

For each SMS message received, the system allows you to:

- read it;
- call the number of the sender directly;
- delete it.

 To do this whilst reading the message, activate the Main Menu and then use the **SRC/OK** or **\ /MENU** buttons to select the desired function.

 Or, with voice interaction:

Press  and say "Read", "Call" or "Delete"; the system will select the chosen option.



DELETING ALL MESSAGES

The system can save up to 20 SMS messages; when a new message is received, the oldest message in the inbox will be deleted. IT IS possible to delete all the SMS messages in the system's memory with a single command.

 Should you wish to delete all messages, activate the system's Main Menu and select DELETE ALL and then press **SRC/OK** or **\ /MENU**; the system will ask you DEL. MESS.?. Confirm the deletion by pressing the **SRC/OK** or **\ /MENU** button, or cancel by pressing the **▶ /ESC** button.

 Or, with voice interaction:

Press  and say "Message reader".

After the audible signal, say "Delete all". **Blue&Me™** will ask you "Delete all messages from the vehicle?"; say "Yes" to confirm the deletion of all SMS messages from the system, or say "No" to cancel the deletion.

SIGNAL SETTINGS

The system's SMS message reader allows you to choose between three notification options for when a new SMS message is received:

○ VIS. + ACOUST.:

the system signals the receipt of a new message both on the panel display and through an audible signal. The system will also suggest reading the message. The **RADIONAV** display will show the reading request:

— turn the OK knob to select the item desired (accept or refuse SMS reading)

— press the OK knob to confirm your choice.

○ VIS. SIGNAL:

the system communicates the receipt of a new SMS message only visually through the panel display. The message received can be read another time (see Read last message received and Inbox sections). The **RADIONAV** display will show only the information of SMS receipt.

○ READER OFF:

the system deactivates the SMS message reader so the receipt of a new SMS message will not be signalled in any way and the message will not be transmitted to the system when it is received.

 Activate the system's Main Menu and select the option MESS. READER, then press **SRC/OK** or **\ /MENU**. Select the SIGNAL TYPE option and scroll through the three options available using the **▲** or **▼** buttons, select the option you want and press **SRC/OK** or **\ /MENU**.

 Or, with voice interaction:

Press  and say "Message reader". After the audible signal, say "Signal type". The system will list the options available, which you can set by saying "Reader off" or "Visual and acoustic signal" or "Visual signal only".

page intentionally left blank



The MEDIA PLAYER menu allows you to:

- display the tracks saved on your USB device
- listen to the audio files saved on your USB device.

Note

Before using the Media Player, in order to make sure that your USB storage device is compatible with the system, read the section on COMPATIBLE USB MEMORY DEVICES or the paragraph about the iPod.

CONNECTING A USB DEVICE TO THE SYSTEM

To connect your USB device to the system, proceed as follows:

- Copy the tracks onto your USB device (the system recognises the following formats: *.wma*, *.mp3*, *.wav*, *.aac* for audio files and *.wpl* and *.m3u* for playlists).
- For USB devices without a USB cable, simply connect the device to the USB port in the car (directly or with the help of an extension) (see fig. 1).

The Media Player does not play audio files covered by digital rights (DRM) and MP4.

- For USB devices with a cable, connect one end to your USB device and the other to the USB port in the car (see fig. 1).
- Turn the car's ignition key to the MAR position. The system will automatically start playing your digital tracks, selecting them from a library that is created the moment the USB device is connected.
- If the AUTOPLAY function is set to "On", the system will automatically start playing your digital tracks.

➡ MEDIA PLAYER — SETTINGS FUNCTIONS.

When the creation of the multimedia library is finished, it is possible to use the system to display and select the tracks present and to activate playback.

MANAGING THE MULTIMEDIA LIBRARY

The Media Player allows you to select the digital audio from your USB device, using steering wheel controls or the **RADIO-NAV** controls. You can scroll through the audio files by folder, artist, genre, album or playlist. You can use voice recognition to choose one of these categories. Once you have selected the category that you want, use the manual controls to select a file. To make it easier to browse your multimedia library, enter the multimedia information (title of the track, artist, album, genre) relating to each track.

Note

Not all formats allow multimedia information to be entered. Amongst the formats recognised by the system, *.mp3*, *.wma* and *.acc* allow for multimedia information, whilst the *.wav* format does not. It may also be the case that multimedia information has not been entered in an audio file that allows for it. In these cases, the selection of audio files can take place only by folder. For more information, refer to the SUGGESTIONS FOR USING MEDIA PLAYER section.

Selecting a folder

If folders containing tracks are saved on your USB device, they are shown in the FOLDERS menu.

 To manually select tracks from the folders, proceed as follows:

Activate the Main Menu, select the MEDIA PLAYER option and then press **SRC/OK** or **\ /MENU**.

Select FOLDERS and then press **SRC/OK** or **\ /MENU**.

Scroll through the available folders. To listen to the entire content of the folders, select PLAY ALL and then press **SRC/OK** or **\ /MENU**. To show all the tracks in the folder displayed, press **SRC/OK** or **\ /MENU**.

Scroll through the tracks in the folder you have selected. To play a track, select the title and press **SRC/OK** or **\ /MENU**. To select a previous or next folder, you can also press the **▲/▼** buttons on the **RADIONAV**. For more information on how to customise the FOLDERS menu, refer to the SUGGESTIONS FOR USING THE MEDIA PLAYER section.

Selecting an artist

 To manually select all the tracks by a particular artist:

Activate the Main Menu, select the MEDIA PLAYER option and then press **SRC/OK** or **\ /MENU**.

Select the ARTISTS option and then press **SRC/OK** or **\ /MENU**.

Scroll through the artists available. To select the artist displayed, press **SRC/OK** or **\ /MENU**.

Scroll through the albums by a particular artist. To listen to an artist's albums, select the option PLAY ALL, then press **SRC/OK** or **\ /MENU**.

To play an album, select it and then press **SRC/OK** or **\ /MENU**.

To play a track by the artist, select the title and press **SRC/OK** or **\ /MENU**. To select a previous or next artist, you can also press the **▲/▼** buttons on the **RADIONAV**.

Note

If your USB device contains lots of audio files, the ARTISTS menu can be divided into alphabetical sub-menus. An alphabetical sub-menu may show only the first letter of the tracks it contains (e.g. A-F), or it may show the first two letters (e.g. Aa-Ar).



Selecting a genre

 To manually select all the tracks from a particular music genre:

Activate the Main Menu, select the MEDIA PLAYER option and then press **SRC/OK** or **\ /MENU**.

Select the GENRES option and then press **SRC/OK** or **\ /MENU**.

Scroll through the available genres. To listen to all the tracks of the genre displayed, press **SRC/OK** or **\ /MENU**.

To select a previous or next genre, you can also press the **▲/▼** buttons on the **RADIONAV**.

Note

If your USB device contains a lot of audio files, the GENRES menu may be divided into alphabetical sub-menus. An alphabetical sub-menu may show only the first letter of the tracks it contains (e.g. A-F), or it may show the first two letters (e.g. Aa-Ar).

Selecting an album

 To manually select an album:

Activate the Main Menu, select the MEDIA PLAYER option and then press **SRC/OK** or **\ /MENU**.

Select the option ALBUM and then press **SRC/OK** or **\ /MENU**.

Scroll through the albums available. To select the album displayed, press **SRC/OK** or **\ /MENU**.

Scroll through the tracks on the album. To listen to all the tracks on an album, select the option PLAY ALL, then press **SRC/OK** or **\ /MENU**. To play an album, select it and then press **SRC/OK** or **\ /MENU**.

To play one track only from an album, select the title of the track and press **SRC/OK** or **\ /MENU**.

To select a previous or next album, you can also press the **▲/▼** buttons on the **RADIONAV**.

Scroll through the albums available. To select the album displayed, press **SRC/OK** or **\ /MENU**.

Scroll through the tracks on the album. To play the entire album, select the PLAY ALL option and then press **SRC/OK** or **\ /MENU**.

To play one track only from an album, select the title of the track and press **SRC/OK** or **\ /MENU**.

Note

If your USB device contains lots of audio files, the ALBUMS menu can be divided into alphabetical sub-menus. An alphabetical sub-menu may show only the first letter of the tracks it contains (e.g. A-F), or it may show the first two letters (e.g. Aa-Ar).

Selecting a playlist

If playlists have been stored on your USB device, you can see them in the PLAYLIST menu.

 To manually select a playlist:

Activate the Main Menu, select the MEDIA PLAYER option and then press **SRC/OK** or **\ /MENU**.

Select the option PLAYLISTS and then press **SRC/OK** or **\ /MENU**.

Scroll through the available playlists. To listen to the playlist displayed, press **SRC/OK** or **\ /MENU**.

To select a previous or next playlist, you can also press the **▲/▼** buttons on the **RADIONAV**.

For more information on creating playlists, refer to the SUGGESTIONS section.

LISTENING TO AUDIO TRACKS

Shuffling the entire multimedia library

The “PLAY ANYTHING” option allows you to play the entire content of your multimedia library in a random order.

 To manually activate the “PLAY ANYTHING” function:

Activate the Main Menu, select the MEDIA PLAYER option and then press **SRC/OK** or **\ /MENU**.

Select the PLAY ANYTHING option and then press **SRC/OK** or **\ /MENU**.

Playing audio

 To manually start listening to digital audio:

If the “AUTOPLAY” function is on, connect your USB device to the system and the tracks will start playing automatically.

➔ MEDIA PLAYER — SETTINGS FUNCTIONS.

With the USB device connected to the system, press MEDIA on the front of the **RADIONAV** until you reach the source “MEDIA PLAYER”.

You can also select the digital audio you want to listen to and then press **SRC/OK** or **\ /MENU** to start playing it.



Pause

To pause the track you are listening to, press **⏸/ESC** or the **⏸** button on the front of the **RADIONAV**.

Resume

To resume listening to a track that you have paused, press **⏸/ESC** or the **▶** button on the front of the **RADIONAV**.

Next track

 To manually move to the next track: When listening to a track, press **▲** (steering wheel controls) or **▶** (**RADIONAV** controls).

Previous track

 To manually go back to the previous track: When listening to a track, press **▼** (steering wheel controls) or **◀** (**RADIONAV** controls).

Note

If the command Previous track is given after the first three seconds of the track, the same track will be played again. If the command is given during the first three seconds of the track, the system will play the previous track.

Changing audio source

To change the active audio source (Radio, CD, Media Player), press **SRC/OK** or the **FM/AM, MEDIA** buttons on the front of the **RADIONAV**.

Note

For further information on the voice commands that can be used with the Media Player, see the LIST OF AVAILABLE VOICE COMMANDS section.

MEDIA PLAYER SETTINGS (only on RADIONAV)

To enter the Media Player settings menu on **RADIONAV**, you can:

- Select the Audio function on the **RADIONAV** Menu, confirm by pressing the OK knob to enter the Media Player, press the OK knob again to confirm the selection and turn to select the desired item.

or

- Select the Media Player source on **RADIONAV** by pressing the **SRC/OK** or **MEDIA** buttons, press the Music button and then press the OK button/knob to confirm the choice and turn to select the desired item.

Automatic play

With the Autoplay function, you can set **RADIONAV** so that the digital audio on your USB device begins to play as soon as you turn the ignition key to the *MAR* position. Once you select this function, your music will start playing automatically the first time that you use the Media Player. Set this function before inserting the device into the vehicle's USB port and creating or updating the multimedia library.

Note

If you change the Autoplay settings after connecting a USB device, the new setting will not take effect until you connect another USB device (or connect the same USB device to your updated library of music tracks).



Shuffle

The Shuffle function changes the digital audio play order. When the Shuffle function is on, the **RADIONAV** plays the digital audio in a random order.

Track loop

When the Loop function is turned on, a track is played repeatedly.

Note

If the Track loop function is on, the play previous track and next track functions will move to the previous or next audio track and start playing this track continuously.

➡ For further information, please see the **RADIONAV** manual.

SUGGESTIONS FOR USING THE MEDIA PLAYER

Scrolling

- To improve scrolling within the FOLDERS menu, organise the folders on your USB device before connecting the device to the system. To facilitate and improve selection in the FOLDERS menu, organise your music tracks into folders that have names that mean something to you.

Organising media files

- To produce categories that mean something on the system, the information in the multimedia files must be updated. To update the information for each file, follow the instructions in the documentation for your multimedia file management software.
- If your library contains items without information relating to the artist, album, title or genre, the system will display UNKNOWN in the ALBUM and GENRE menus. To enter information in a digital audio file, follow the instructions in the documentation for your multimedia file management software.
- To enhance the experience of listening to your favourite music, we suggest creating specific playlists (see “Creating playlists” in this chapter).

Creating the multimedia library

- It may take a few minutes to create the multimedia library. If it is taking too long to create the library, you can reduce the number of audio files stored on your USB device.
- You can still listen to a selection of your songs while the library is being created. The system will continue to create the library whilst the music is playing.

Creating playlists

To create a *.m3u* or *.wpl* playlist for the system by using Microsoft® Windows Media® Player, proceed as follows:

- Copy all the songs that you want for the playlist into a new folder or onto your USB storage device.
- Open Microsoft® Windows Media® Player. Select File, Open from the menu.
- Scroll through the contents of the USB device connected to your computer and select the audio files that you want to add to the playlist.
- Click on Open.
- Move onto “File” and select “Save playlist as...” ... Enter the name you want in the field “File name” and set the type *.wpl* or *.m3u* in the “Save as” field.
- Click on Save.

Once the previous stages are completed, the new *.m3u* or *.wpl* file will be created.



The SETTINGS menu gives you the following choices:

- Privacy function management
- Managing user data
- Pairing a mobile phone
- Advanced options.

To operate within the SETTINGS menu when the car is stationary, you can use either the steering wheel controls or voice commands. When the car is moving, you can use only voice commands. Instructions for both methods follow.

➔ If you have any difficulty using the system's settings functions, consult the TROUBLESHOOTING section.

PRIVACY FUNCTION MANAGEMENT

It is possible to set the "Privacy" function to limit the telephone settings display (name/number of the person making the call, name/number of the person being called or name/number of the sender of the SMS message) on the panel display without them being displayed on the central **RADIONAV** display.

🗨️ To access the PRIVACY menu manually, proceed as follows: access the main menu by pressing **\ /MENU**, select the SETTINGS option by pressing **SRC/OK** or **\ /MENU**, select the PRIVACY option and then press **SRC/OK** or **\ /MENU**.

To activate the function, select PRIVACY ACTIVE and then press **SRC/OK** or **\ /MENU**.

To deactivate the function, select PRIVACY OFF and then press **SRC/OK** or **\ /MENU**.

🗨️ To access the PRIVACY menu using voice interaction:

press **Windows** and say "Settings". At the end of the message from the system, say "Activate Privacy" to activate the function or say "Deactivate Privacy" to deactivate the function.

MANAGING USER DATA

The user data saved in the hands-free system can be altered. In particular, you can delete the data relating to the mobile phones registered on the system, delete the active phonebook at a given moment or delete both at the same time. In this way, the system is restored to its original settings. It is also possible to transfer the phonebook or individual contacts from the mobile phone to the hands-free system, if this has not been done during the registration process. You can amend the data used by the system via the USER DATA OPTION.

 To access the USER DATA menu manually, proceed as follows: activate the Main Menu by pressing **\ /MENU** and select SETTINGS by pressing **SRC/OK** or **\ /MENU**.

Select the option USER DATA and then press **SRC/OK** or **\ /MENU**.

 Or, with voice interaction:

Press  and say "Settings" and then, at the end of the message from the system, say "User Data". You can carry out the functions described below in the USER DATA menu.

Delete the registered users

In the USER DATA menu, you can delete registrations. Once you have done so, you can no longer use the hands-free system with an unregistered mobile phone, nor can you use your phonebook, until the mobile phone is registered again. Remember that this operation cancels all registrations on the system.

 To manually delete the registration data for all users, proceed as follows:

Select the option DELETE USERS and then press **SRC/OK** or **\ /MENU**.

The system will display the message DELETE USERS?. To delete the user data, confirm by pressing **SRC/OK** or **\ /MENU**.

 Or, with voice interaction:

Press  and say "Settings" and then, at the end of the message from the system, say "Delete Users".

The system will ask "Delete all registered users?". To confirm, say "Yes".

Notes

- Always remember that, if a mobile phone is paired on the system whilst another phone is connected, the connection with the telephone connected at that time will be interrupted and the new telephone will be connected.

- It is not possible to delete user data for a single mobile phone unless it is the only one registered.

- After the user data is deleted, you will need to register a mobile phone again.

Delete the phonebook

In the USER DATA menu, you can also delete the phonebook copied onto the system.

 To manually delete the current mobile phonebook, proceed as follows:

Select the option DEL. PHONEBOOK and then press **SRC/OK** or **\ /MENU**. The system will display the question "Del. phonebook?". To delete the phonebook, confirm by pressing **SRC/OK** or **\ /MENU**.

 Or, with voice interaction:

Press  , say "Settings" and then, at the end of the message from the system, say "Delete phonebook".

The system will ask "Delete the copy of the phonebook from the car?". To confirm, say "Yes".



Copy the phonebook

If you chose not to copy the phonebook during registration or you have recently deleted your contacts, go into the USER DATA menu and choose PHONEBOOK.

 To manually copy the phonebook from a registered phone, proceed as follows:

Select the option PHONEBOOK and then press **SRC/OK** or **\ /MENU**.

 Or, with voice interaction:

Press , say "Settings" and then, at the end of the message from the system, say "Copy phonebook".

Add contacts

If your mobile phone does not support the automatic saving of the phonebook whilst pairing the telephone, the ADD CONTACTS option will be available in the USER DATA menu.

 To manually transfer the contacts on your mobile phone to the hands-free system, proceed as follows:

Select the option ADD CONTACTS and then press **SRC/OK** or **\ /MENU**.

 Or, with voice interaction:

Press , say "Settings" and then, at the end of the message from the system, say "Add contacts".

Then follow the instructions in your mobile phone manual on transferring contacts from the phone to another device.

Delete all data

 To manually restore the hands-free system to its original settings, deleting all the data and the contacts for all the phones paired, proceed as follows:

Select the option DELETE ALL and then press **SRC/OK** or **\ /MENU**.

The system will display the question "Delete all?". To delete all the data, confirm by pressing **SRC/OK** or **\ /MENU**.

 Or, with voice interaction:

Press , say "Settings" and then, at the end of the message from the system, say "Delete all".

The system will ask "Delete all data saved by users from the car?". To confirm, say "Yes".

REGISTERING A MOBILE PHONE

In order to use your mobile phone with the vehicle's hands-free function, it must be registered. During the pairing process, the hands-free system searches for a phone with **Bluetooth**® technology in its reception range. If it finds one, it establishes a connection with it by using a Personal Identification Number (PIN). After you have registered your mobile phone on the system, you can use it with the hands-free system.

IMPORTANT The PIN code used for registering a mobile phone is produced randomly by the system each time a new phone is registered, therefore you do not need to remember it. If you lose it, you can still use the hands-free system.

The procedure for registering your mobile phone has to be carried out only once; afterwards, the system will automatically connect your phone each time you get into the car and turn the ignition key to the MAR position.

You can pair your mobile phone using the **REGISTRATION** option in the **SETTINGS** menu.

 To perform the pairing manually, proceed as follows:

Activate the Main Menu by pressing **\ /MENU** and select the Settings option by pressing **SRC/OK** or **\ /MENU**.

Select the option Registration and then press **SRC/OK** or **\ /MENU**. The system begins the registration process.

The system displays the PIN code necessary for registering the mobile phone on the instrument panel and repeats it out loud. It is important to know that this PIN is used only for registering the mobile phone; it is not your SIM card PIN.

For the two subsequent stages, consult your mobile phone manual for how to register and connect with **Bluetooth**® devices.

On your mobile phone, look for the option that allows you to display **Bluetooth**® devices within the operating range (this option may be called Search, Add Device, etc. on your mobile phone). From the **Bluetooth**® devices found, select "**Blue&Me**" (the name identifies the system on your car).

When prompted by your phone, enter the PIN number shown on the instrument panel display. If the registration was successful, the system will say "Connecting" and at the end the display will show, as confirmation, details of the mobile phone registered.

It is important to wait for this confirmation message; if you press **\ /MENU** or **▶ /ESC** before it appears, you risk cancelling the registration process. If registration fails, an error message will appear; in this case, you will need to start again.



The first time a mobile phone is registered, the system says “Welcome” immediately after the connection. This welcome message will not be delivered during subsequent registrations or connections of the same mobile phone.

The system will ask you if you want to copy across the contacts of the phone you have just registered. Copying the phonebook is recommended. To copy the phonebook, press **SRC/OK** or **\ /MENU**. To not copy the phonebook, press **▶ /ESC**. If you do not copy the phonebook at this point, you can copy it later on using the **SETTINGS**, **USER DATA**, **PHONEBOOK** menu option.

On some mobile phones, the names in the phonebook are not copied automatically, but have to be transferred by using the mobile phone keypad. If prompted by the system, carry out this procedure following the specific instructions for your mobile phone and press **\ /MENU** when you have finished.

Or, with voice interaction:

Press **⊞** and say “Settings” and then, at the end of the message from the system, say “User pairing”.

The system displays the PIN code for registration on the instrument panel and repeats it out loud.

For the next two stages, consult your mobile phone manual on how to register and connect with **Bluetooth®** devices.

On your mobile phone, look for the option that finds in-range **Bluetooth®** devices (it may be called Search, Add Device, etc.). From the **Bluetooth®** devices found, select “**Blue&Me**” (the name that identifies the hands-free system on your car).

When prompted by your mobile phone, enter the PIN shown on the display using your mobile phone keypad. If the registration was successful, the system will say “Connecting” and at the end the display will show, as confirmation, details of the mobile phone registered.

It is important to wait for this confirmation message; if you press **\ /MENU** or **▶ /ESC** before it appears, you risk cancelling the registration process. If registration fails, an error message will appear; in this case, you will need to start again.

The first time you register a mobile phone, the system will say “Welcome” straight after connection. In subsequent registration procedures or when connecting the same mobile phone, the system will not give this welcome message.

The system will ask you if you want to copy the phonebook of the phone just registered. Copying the phonebook on to the system is recommended. To copy the phonebook, say "Yes". To not copy the phonebook, say "No".

On some mobile phones, the names in the phonebook are not copied automatically, but have to be transferred by using the mobile phone keypad. If the hands-free system asks you, carry out this procedure following the specific instructions for your mobile phone and press **\ /MENU** when you have finished.

Suggestions

To improve the voice recognition of the names in your phonebook and the accuracy of the system's pronunciation, try and enter the names in your phonebook and save them using the following criteria:

- Avoid abbreviations.

- Write foreign names the way they are pronounced, according to the rules of the system language set on your car. For example, it is advisable to enter "Thorsten" as "Torsten" to improve recognition and get the system to pronounce the names correctly.
- When you add or amend names in the phonebook, enter the appropriate signs for any accents so that they are pronounced correctly and recognised by the system. For example, it is advisable to enter "Nicolo Reborra" as "Nicolò Réb-ora" to get the correct pronunciation.
- When you add or amend names in the phonebook, remember that some isolated upper-case letters can be read as roman numerals (e.g. V can be read as five).
- When you call people using voice recognition, do not use shortened versions of the name or middle initials.

Note

- Your mobile phone has to be registered only once.
- You can register up to five mobile phones on the system, which can be used one at a time.
- To connect a mobile phone to the system that has already been registered, you always need to switch on the phone's **Bluetooth**® setting.
- Before you transfer the contacts from your mobile phone to the hands-free system, make sure the name of each person is unique and clearly recognisable, so that the voice recognition system functions properly (not all mobile phones support the automatic phonebook download).
- The system will copy only valid contacts, i.e. those that contain a name and at least one telephone number.



- If you want to register your mobile phone again, the old registration must be deleted first. During this operation, all the user data registered on the system will be deleted. To delete the old registration, use the USER DATA, DELETE USERS menu option. On your mobile phone, delete the “Blue&Me” device from the list of **Bluetooth**® devices, following the instructions in your mobile phone manual (not all mobile phones can automatically download the phonebook).
- If a phonebook is copied that contains more than 1000 contacts, the system may operate more slowly and the voice recognition of the names in your phonebook may be impaired.
- If you accidentally cancel your registration, you will need to repeat the process.

ADVANCED OPTIONS

 To manually access the ADV. OPTIONS menu, proceed as follows:

Access the Main Menu by pressing **\ /MENU** and select the SETTINGS option by pressing **SRC/OK** or **\ /MENU**.

Select ADV. OPTIONS and then press **SRC/OK** or **\ /MENU**.

 Or, with voice interaction:

Press  and say “SETTINGS” and then “ADVANCED OPTIONS”.

In the ADV. OPTIONS menu, you can access the SYS. CODE and change the GPRS code.

Note

The SYS. CODE is an eight-digit number which uniquely identifies the system on your vehicle and cannot be changed.

Accessing the system code

To carry out some of the operations it may be necessary to know the identification code for your system.

 To manually gain access to this code, proceed as follows:

Select SYS. CODE and then press **SRC/OK** or **\ /MENU**.

The panel display will show the code for your system.

To exit this display, press **SRC/OK** or **\ /MENU** or **▶ /ESC**.

 Or, with voice interaction:

Press  and say “Settings”, and then, at the end of the message supplied by the system, say “Read code”.

The panel display will show the code for your system.

To exit this menu option, press **SRC/OK** or **\ /MENU** or **▶ /ESC**.

Changing the GPRS connection code

If the mobile phone manager requires a setting change for the GPRS connection, you can do it in the menu ADV. OPTIONS.

 To change the GPRS connection code manually:

Move to the GPRS CODE menu and press **SRC/OK** or **\ /MENU**.

GPRS should appear on the display with a list of digits (1, 2, 3, 4, 5, 6, 7, 8, 9), DEFAULT and DISABLE. To select a new code for the GPRS connection, press **▲** or **▼** until the desired option appears, then press **SRC/OK** or **\ /MENU**. To choose to keep the default value, select DEFAULT. To disable the connection code, select DISABLE.

After having reset the GPRS connection code, the system will display the message GPRS CODE SET.

 To set the GPRS connection code using voice interaction:

Press  and say "Settings" and then "Connection code".

The system will reply with "The current GPRS connection code is" and the current value. To change it, say a number from 1 to 9 or say "Default". To disable it, say "Disable". To change the code, say a number from 1 to 9 or say "Default". To disable the code, say "Disable". (In the previous sentence, the current value is the value set for the GPRS connection code at the time it is used).

After having set the new connection code, the system responds with "The connection code is the new value" (In the previous sentence, new value is the new value set for the GPRS connection).

EXIT SETTINGS MENU

At the end of each operation, you can exit the settings menu as follows.

 To manually exit the SETTINGS menu:

Select the option EXIT and then press **SRC/OK** or **\ /MENU**.

 Or, with voice interaction:

Press  and say "Exit".



Blue&Me™ communicates with your personal devices using **Bluetooth®** technology and USB.

For up-to-date information on the compatibility of personal devices with **Blue&Me™**, go to an Alfa Romeo Dealership or consult the dedicated area on www.alfaromeo.com.

MOBILE PHONES WITH Bluetooth® TECHNOLOGY

Blue&Me™ is compatible with most mobile phones that support **Bluetooth®** 1.1 and Hands-Free profile 1.5 (refer to the **Bluetooth®** connection specifications in the mobile phone handbook).

As a result of the different software versions available on the market for different models of mobile phone, some additional functions (e.g. second call management, call transfer from hands-free system to mobile phone and vice versa, etc.) may not correspond exactly to the description in the mobile phone user manual. In any case, your ability to have a hands-free conversation is not compromised.

Mobile phones with phonebook management

If your mobile phone is able to automatically transmit contacts via **Bluetooth®**, the entire phonebook will automatically be copied onto **Blue&Me™** during registration.

To consult the list of mobile phones and functions supported, go to the dedicated **Blue&Me™** section at www.alfaromeo.com or call customer services on 00800.2532.0000.

Here, you can find:

- a quick guide with usage tips;
- a quick guide for using your mobile phone for registering;
- advice on connecting to an iPod;
- the nine available voice recognition language files that can be downloaded individually onto **Blue&Me™** (Italian, French, English, German, Spanish, Portuguese, Dutch, Polish, Brazilian).

Mobile phones with management of single contacts

If your mobile phone is able to transmit individual phonebook contacts via **Bluetooth®**, during the registration procedure you will be asked to transfer the names using your phone.

Mobile phones with SMS message management (not all mobiles support listening to incoming text messages)

If your mobile phone is able to transmit SMS messages via **Bluetooth®**, you can read incoming texts via the **Blue&Me™** hands-free system, save them to an inbox or delete them.

COMPATIBLE USB STORAGE DEVICES

USB storage devices

The Media Player is compatible with most USB 1.0, 1.1 or 2.0 mass storage devices.

Managing audio files from iPod devices

To optimise the connection of your iPod with **Blue&Me™**, you should carry out a few simple operations on your iPod:

- configure the iPod for use as an external disc, referring to the iPod user manual;
- if the configuration has been made on an Apple computer, configure it in Windows;
- save the music tracks as audio files compatible with **Blue&Me™**.

These operations do not adversely affect the listening quality nor the usability of tracks managed by iPods.

What can I do?

- Listen to tracks in digital quality
- Select tracks (by artist, album, genre, etc.) through voice control or by using the steering wheel controls
- Display information about the track being played (song title, singer, etc.) on the instrument panel.
- Recharge the iPod through the USB port.

What can I not do?

- Play audio tracks from iPod devices not configurable as external disks or iPhones (without **Blue&Me™** Media Player adapter, see Note below).

Note

A **Blue&Me™** Media Player adapter is available from Lineaccessori Alfa Romero, allowing you to play music tracks from iPod or iPhone models that cannot be configured as an external disk.



Note

USB devices with a “password” function are not recommended. If your USB device has such a function, always check that it has been deactivated.

The Media Player has only one multimedia library. When a new USB device is inserted, **Blue&Me™** creates a new library to replace the existing one.

Compatible digital audio files

The Media Player can play audio files in the following formats:

Extension	Audio coding
.wma	Supports WMA version 1 and WMA version 2 standards. (WMA2 = 353, WMA1 = 352). Supports WMA Voice audio formats.
.mp3	MPEG—1 Layer 3 files (sampling frequencies 32 kHz, 44.1 kHz and 48 kHz) and MPEG—2 Layer 3 files (16 kHz, 22.05 kHz and 24 kHz). The following bit rates are supported: 16 kbps, 32 kbps, 64 kbps, 96 kbps, 128 kbps and 192 kbps. Also supports the Frunhofer MP2.5 extension (sampling frequencies 8 kHz, 11.025 kHz and 12 kHz).
.wav	audio in digital format, without data compression.
.aac .M4A MP4	MPEG-4 files (sampling frequencies between 22.05 kHz and 48 kHz) The following bit rates are supported: 8kbps and 529 kbps

Note

The Media Player does not support compressed audio files with other formats and DRM (Digital Rights Management) protected audio files. If there are unsupported audio files on the USB device, they will be ignored.

Compatible playlist formats

The Media Player can play playlists in the following formats:

- .m3u — file containing a playlist. (versions 1 and 2);
- .wpl — Windows®-based file that contains a playlist. (the capacity limit of the playlist in this format is 300 kB). You can create .wpl playlists by using Microsoft® Windows Media® Player.

The Media Player does not support nested or connected playlists. Both relative and absolute paths to songs in the playlists are supported.

The Media Player does not support playlists generated by a software application based on special preferences or criteria.

The playlists created by an iPod cannot be read.

The Media Player will play playlists that include paths that lead to digital audio files in the folder.

For further information on creating playlists for **Blue&Me™**, refer to the SUGGESTIONS FOR USING THE MEDIA PLAYER section.

Note on brands

Microsoft® and Windows® are registered trademarks of Microsoft Corporation.

Sony® is a registered trademark of Sony Corporation.

Ericsson® is a registered trademark of Telefonaktiebolaget LM Ericsson.

Motorola® is a registered trademark of Motorola, Inc.

Nokia® is a registered trademark of Nokia Corporation.

Siemens® is a registered trademark of Siemens AG.

Orange™ is a registered trademark of Orange Personal Communications Services Limited.

Audiovox® is a registered trademark of Audiovox Corporation.

Bluetooth® is a registered trademark of Bluetooth® SIG, Inc.

Lexar™ and JumpDrive® are registered trademarks of Lexar Media, Inc.

SanDisk® and Cruzer™ are registered trademarks of SanDisk Corporation.

iPod, iTunes and iPhone are registered trademarks of Apple Inc.

All the other trademarks are property of their respective owners.



The following tables show the voice commands available on the system. For each command, the “main” command is shown and then synonyms that can be used.

TABLE OF PERMANENTLY AVAILABLE VOICE COMMANDS

- Help
- Menu
- Options

*Turns on the “**Help**” function, providing a list of voice commands available at the current level*

- Cancel

Cancels voice interaction and turns off the voice recognition system

- Repeat

Repeats the last message from the hands-free system

TABLE OF HANDS-FREE VOICE COMMANDS

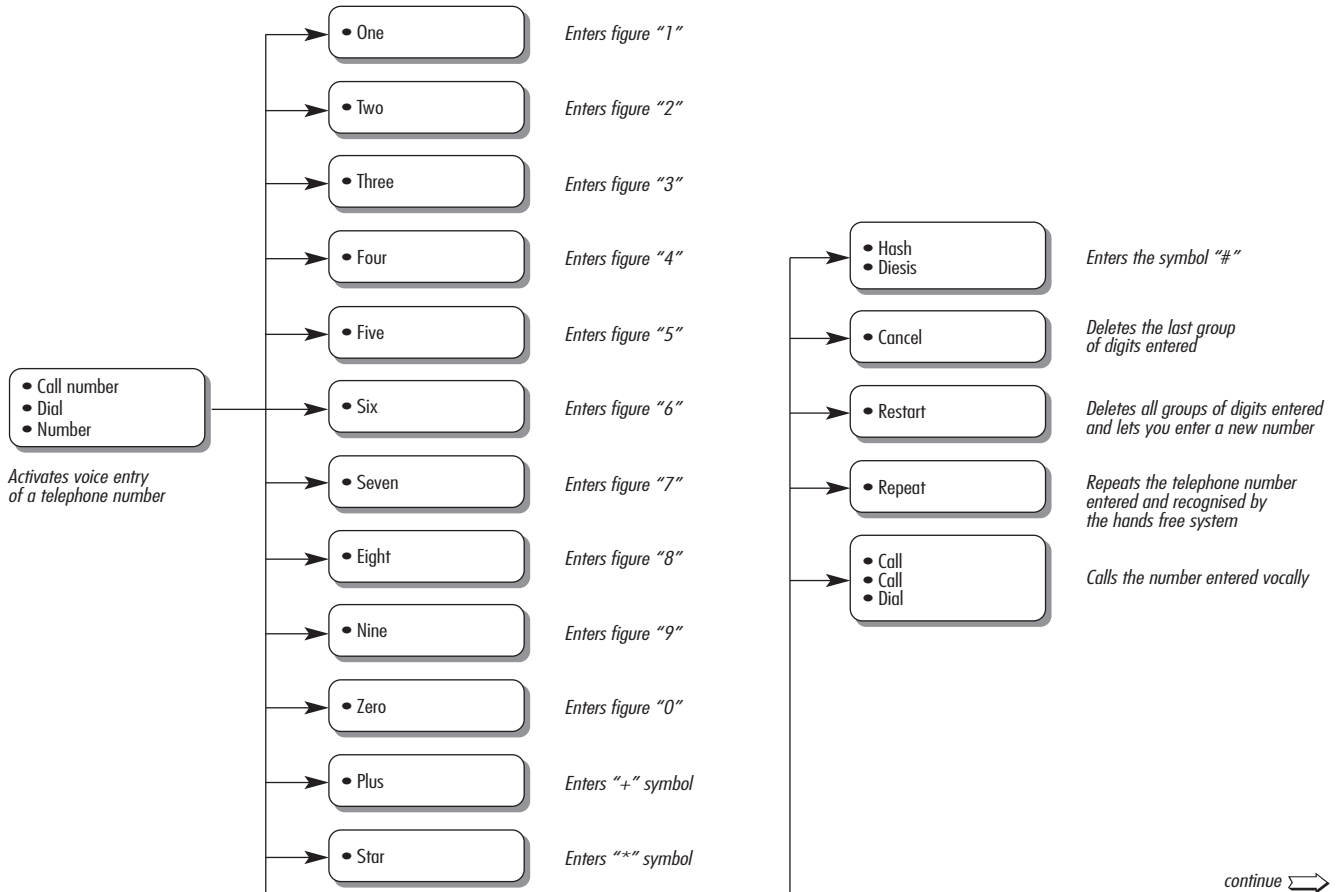



⇒ *continued*

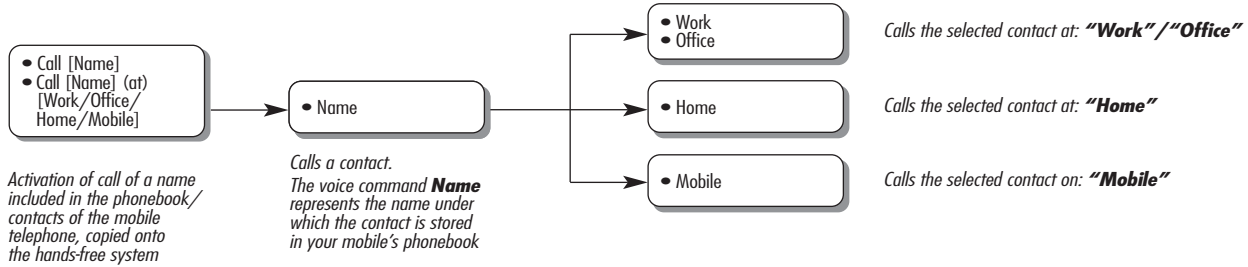

• Phone
• Telephone

Enables telephone function, with voice instructions on using the hands-free system

• Call back

Dials the telephone number of the last person who called you

• Redial

Dials the last number called

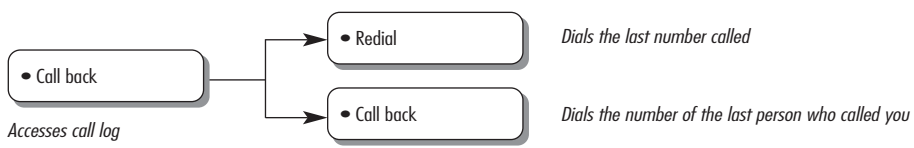

TABLE OF SMS MESSAGE READER VOICE COMMANDS

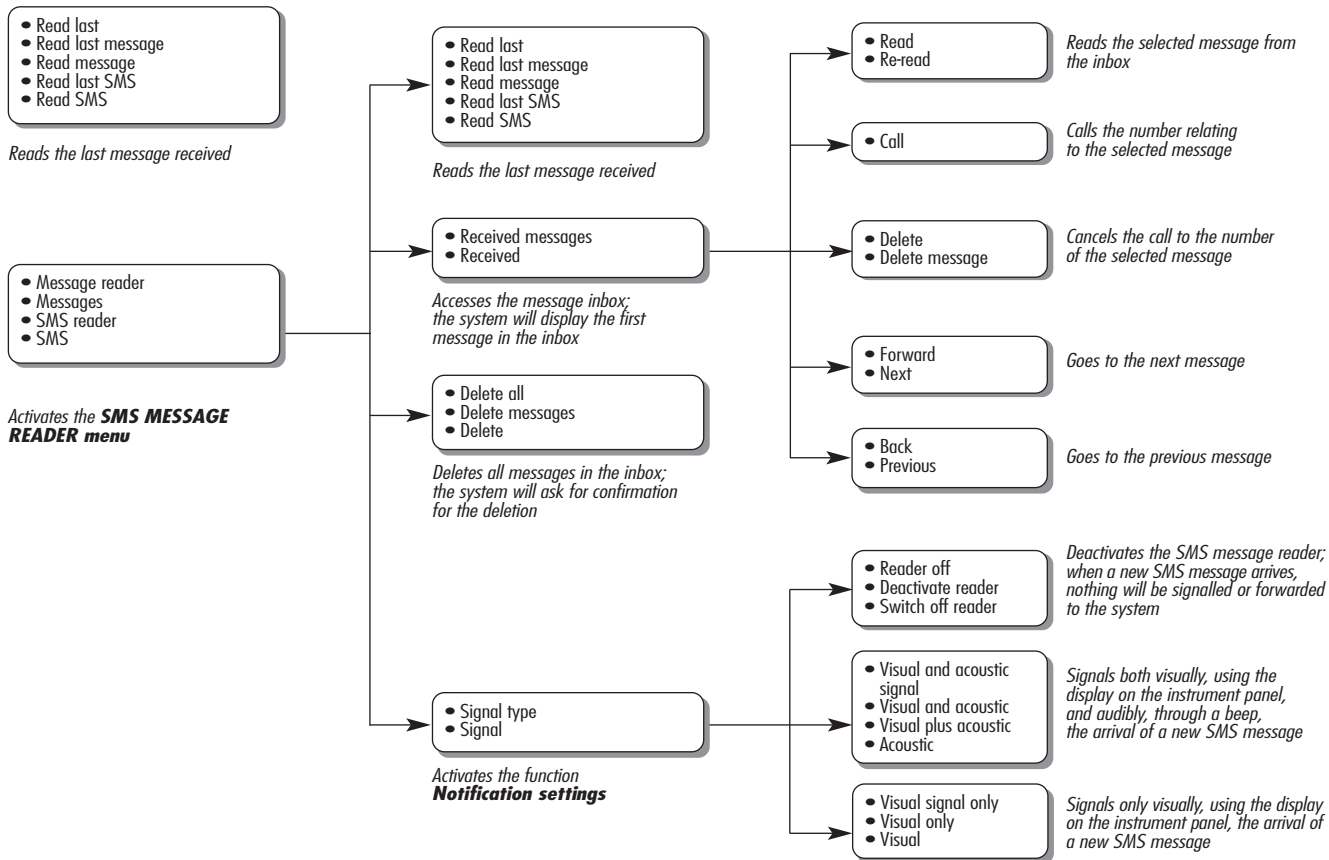
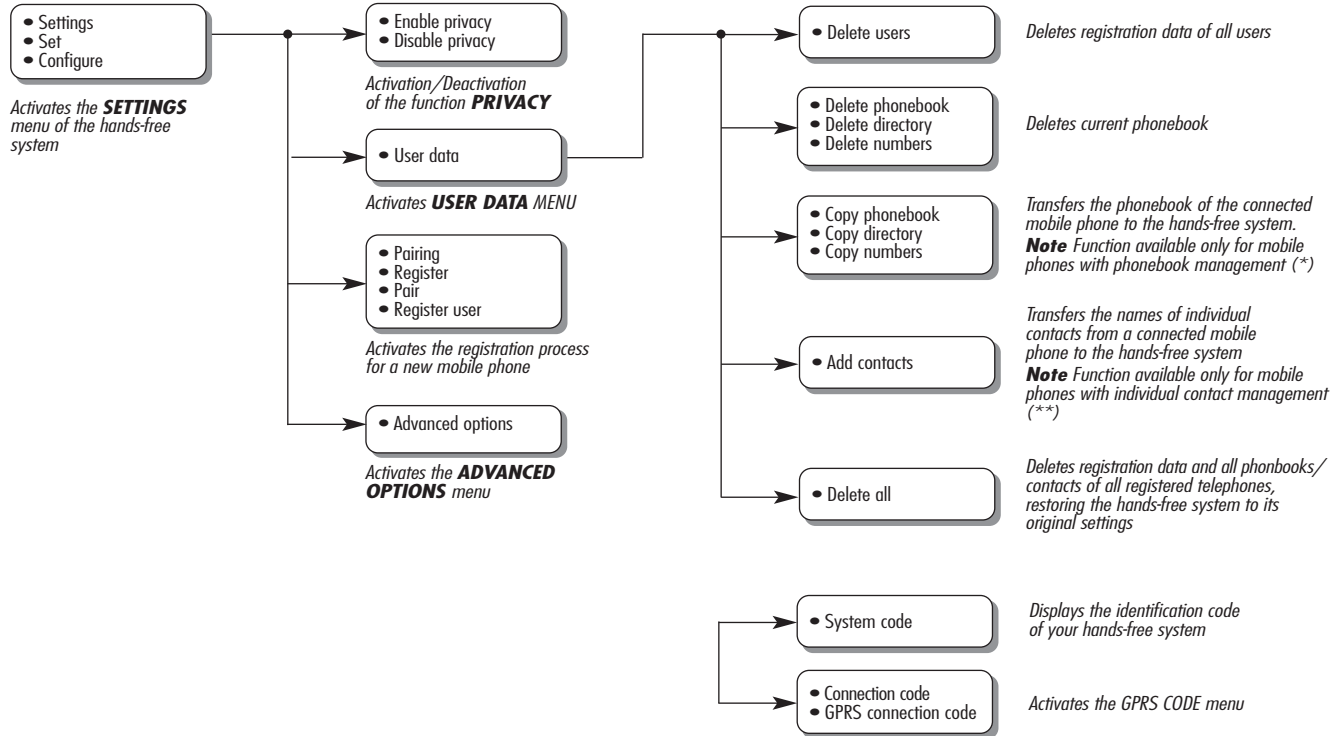



TABLE OF VOICE COMMANDS FOR SETTINGS



(*) If your phone can automatically forward its contacts via **Bluetooth®**, the entire phonebook will be automatically copied to the hands-free system during registration.
(**) If your phone can forward individual contacts from the phonebook via **Bluetooth®**, during the registration process you will be asked to transfer the names using your mobile phone.

page intentionally left blank



HANDS FREE

General problems

Problem	Probable cause	Possible solution
<p>The display shows: NO CONTACTS</p> <p>Or, the system says: "As requested by the user, the phonebook has not been copied. To copy the phonebook to the vehicle, move to the SETTINGS menu and select USER DATA. To dial a phone number, say "Call number"."</p>	<p>Mobile phones with contacts management</p> <ul style="list-style-type: none"> ○ When the system asked "The data from the phonebook will be copied to the vehicle. Continue?", you replied "No" ○ You have not downloaded the phonebook using the SETTINGS menu ○ The downloaded phonebook has been deleted <p>Mobile phones with individual contact management</p> <ul style="list-style-type: none"> ○ When the system asked "The data from the phonebook will be copied to the vehicle. Continue?", you replied "No". ○ You have not transferred the names in your phonebook onto the system using the ADD CONTACTS procedure ○ The downloaded phonebook has been deleted 	<p>Mobile phones with contacts management</p> <ul style="list-style-type: none"> ○ Use the option PHONEBOOK from the menu SETTINGS to download the phonebook ○ Enter the contacts' data in your mobile's phonebook and then download the phonebook ➔ SETTINGS FUNCTIONS — MANAGING DATA AND THE PHONEBOOK <p>Mobile phones with individual contact management</p> <ul style="list-style-type: none"> ○ Use the option ADD CONTACTS from the menu SETTINGS to transfer the names from your mobile's phonebook to the system ➔ SETTINGS FUNCTIONS — MANAGING DATA AND THE PHONEBOOK





Problem	Probable cause	Possible solution
<p>The display shows: PHONEBOOK EMPTY</p> <p>Or the system says “No name in the phonebook. To add contacts to the phonebook, go to the SETTINGS menu and select “USER DATA”. To dial a phone number, say “Call number.”</p>	<p>Mobile phones with contacts management</p> <ul style="list-style-type: none"> ○ You replied “Yes” to “The data from the phonebook will be copied to the vehicle. Continue?” but the phonebook downloaded does not contain valid names ○ You have used the option PHONEBOOK in the menu SETTINGS but the mobile’s phonebook does not contain valid contacts <p>Mobile phones with individual contact management</p> <ul style="list-style-type: none"> ○ When the system asked “The data from the phonebook will be copied to the vehicle. Continue?”, you replied “Yes” but you have not transferred valid names during the ADD CONTACTS PROCEDURE ○ You have used the option ADD CONTACTS but you have not transferred valid contacts to the system 	<p>Mobile phones with contacts management</p> <ul style="list-style-type: none"> ○ Enter valid contacts (a name and at least one phone number) in the phonebook of your mobile phone and then download the phonebook ➔ SETTINGS FUNCTIONS – MANAGING DATA AND CONTACTS <p>Mobile phones with individual contact management</p> <ul style="list-style-type: none"> ○ Download the phonebook again and make sure you transfer valid contacts to the hands-free system using your mobile phone, when requested by the system ○ Use the option ADD CONTACTS in the menu SETTINGS to transfer the names from your mobile phone to the hands-free system ➔ SETTINGS FUNCTIONS – MANAGING DATA AND THE PHONEBOOK



Problem	Probable cause	Possible solution
<p>The display shows: NO TELEPHONE Or the system says "No phone connected"</p>	<ul style="list-style-type: none"> ○ The mobile phone paired is switched off ○ The mobile registered is not within the system's operating range (it should be within about 10 m from the system) ○ The Bluetooth® connection between the system and the mobile has been disabled on your mobile phone ("Blue&Me™" identification) 	<ul style="list-style-type: none"> ○ Turn the mobile phone on ○ Make sure that your phone has been registered ○ Make sure that the Bluetooth® connection between your mobile phone and the car's hands-free system (identified by "Blue&Me™") is active ○ Make sure that the mobile phone that you registered on the vehicle's hands-free system is within the system's operating range
<p>The display shows: PHONE DISCONNECTED</p>	<ul style="list-style-type: none"> ○ An error has been detected in your mobile phone's Bluetooth® connection ○ During a phone conversation, the mobile phone left the hands-free system's operating range 	<ul style="list-style-type: none"> ○ Turn the mobile phone off and on again to restore the connection with the system ○ Restore the system by turning the ignition key to STOP and then back to MAR
<p>The display shows: REGISTRATION FAILED Or the system says "Registration unsuccessful. Please try again"</p>	<ul style="list-style-type: none"> ○ There has been an error during the registration procedure 	<ul style="list-style-type: none"> ○ Check that the PIN number is correct and try and enter it again ○ Turn the mobile phone off and on again and then repeat the registration process ➡ SETTINGS FUNCTIONS – MOBILE PHONE REGISTRATION

Problem	Probable cause	Possible solution
<p>The display shows: PAIR. FAILED</p> <p>Or the system says "Pairing failed. Please try again."</p>	<p>After three minutes from when the system provides the PIN code needed to register the mobile phone, you will no longer be able to enter the code</p>	<p>Repeat the registration procedure. When you enter the PIN, check that the PIN number you enter on your mobile is the same as that shown on the instrument panel multifunction display</p> <p>➡ SETTINGS FUNCTIONS – MOBILE PHONE REGISTRATION</p>
<p>The display shows: PRIVATE NUMBER</p>	<ul style="list-style-type: none"> ○ The caller is not recognised as a saved contact in the phonebook and the mobile phone registered is not capable of displaying the identity of the caller ○ The caller has withheld their ID to stop you seeing their name and/or number 	<p>Enter in your mobile's phonebook a name that corresponds to the number of the incoming call and then download the phonebook/contact to the hands-free system again</p> <p>In this case, there is nothing that can be done and the message will always appear</p>
<p>The display shows: ONLY AT REST</p> <p>Or the system says: "This function is enabled only when the vehicle stationary"</p>	<p>Even just glancing occasionally at the instrument panel display can be dangerous and distract your attention away from the road. Some functions of the system require the user to pay attention to the instrument panel display and are available only when the vehicle is stationary</p>	<p>Stop the vehicle and try to activate the function manually or keep driving and perform the function by using the voice recognition system</p>



Problem	Probable cause	Possible solution
<p>The system does not respond to a voice command or to the press of a button</p>	<ul style="list-style-type: none"> ○ If you do not speak soon enough after pressing , the system stops the voice interaction ○ If you speak too far away from the car's microphone (for example, if you are sitting on the back seat), the system may not recognise your voice command ○ If, after having pressed , you do not wait for the audible signal, the system will receive only part of your voice command and it will not recognise it ○ If you do not press  before giving a voice command, the system does not activate voice recognition and will not be able to recognise your commands ○ If you do not press \ /MENU to enter the Main Menu, you cannot manually access the system's functions management menu ○ If you do not act within about eight seconds from pressing \ /MENU, the system will no longer respond to button pressing 	<ul style="list-style-type: none"> ○ Press  and give the voice command again Make sure you speak clearly at a normal volume ○ Press \ /MENU and try again manually. Make sure that you act within eight seconds from pressing \ /MENU

Problem	Probable cause	Possible solution
The system prompts you to enter a PIN code, but you are not registering a phone	After you have deleted the user information relating to the registration of your mobile phone, the Bluetooth® connection between the phone and the system is no longer active	Select DELETE USERS on the system and delete all the registrations, then register the mobile phone again ➤ SETTINGS FUNCTIONS – MANAGING DATA AND THE PHONEBOOK ➤ SETTINGS FUNCTIONS – REGISTERING YOUR MOBILE PHONE
When you are very near the vehicle and you take a call with the “answer” button on your mobile phone, the vehicle’s hands-free function is automatically activated (the caller’s voice is played over the speakers in the passenger compartment)	For some types of mobile phone, you need to set the incoming call management mode either to automatic transfer to the hands-free system or transfer on request (by means of specific controls on the mobile phone)	Refer to your mobile phone’s manual to find out how to configure the call management mode



Problem	Probable cause	Possible solution
<p>If you try and register a phone that has already been registered, the display shows: PAIRING UNSUCCESSFUL</p> <p>Or the system says “PAIRING UNSUCCESSFUL. PLEASE TRY AGAIN”</p>	<p>Before repeating the registration of a mobile phone that has already been registered, you need to delete the information relating to the previous registrations on the system</p>	<p>Remember that it is necessary to perform the registration procedure only once; afterwards, the system will automatically connect your mobile phone every time you get in the vehicle and turn the ignition key to the MAR position.</p> <p>If you need to repeat the registration of a mobile phone that has already been registered, select DELETE USERS on the system and then repeat registration</p> <ul style="list-style-type: none"> ➤ SETTINGS FUNCTIONS — MANAGING DATA AND THE PHONEBOOK ➤ SETTINGS FUNCTIONS — REGISTERING YOUR MOBILE PHONE
<p>After having copied the mobile’s phonebook to the hands-free system, the titles, qualifications or middle initials (Mr, Dr, BA, QC, etc.) in the name have not been recognised by the voice recognition system</p>	<p>When you call a contact in your mobile phonebook using voice commands, the voice recognition system does not support the use of titles, qualifications or middle initials</p>	<p>When you call a contact in your mobile’s phonebook using voice recognition, say the name without using titles, qualifications or middle initials. If you have two contacts with similar names and/or surnames in your mobile’s phonebook, change one of the names to make it unique and copy the phonebook onto the hands-free system again</p>

Problem	Probable cause	Possible solution
In some cases, it is not possible to call phone numbers that contain an international prefix (e.g. +39 Italy, +44 UK, +33 France etc.)	When a transfer of names and/or telephone numbers is carried out from the mobile phone to the hands-free system, for some mobile phones the "+" symbol is omitted	Replace the "+" at the start of the country prefix with "00" (e.g. +39 becomes 0039).

To consult the list of mobile phones and functions supported go to the dedicated **Blue&Me™** section at www.alfaromeo.com or call Customer services on 00800.2532.0000.

Here, you can find:

- a quick guide with advice on usage;
- a guide for using your mobile phone for registering;
- advice on connecting to an iPod;
- the nine available voice recognition language files that can be downloaded individually onto the system (Italian, French, English, German, Spanish, Portuguese, Dutch, Polish, Brazilian).



SMS MESSAGE READER

Problem	Probable cause	Possible solution
I can receive SMS messages on my mobile phone but not on the system	Not all mobile phones support the transfer of SMS messages to the system	Check that your mobile phone supports the function of transferring SMS messages by Bluetooth ® technology or, for further information, refer to the chapter LIST OF PHONES SUPPORTED BY THE SYSTEM, the dedicated Blue&Me ™ chapter at www.alfaromeo.com or customer services on 00800.2532.0000.
The SMS messages received from the phone provider's service centre incorrectly display the sender's name or number	Not all mobile phones support the correct transfer to the system of the name of the service provider that has sent the SMS message	—
The system has stopped receiving messages from your mobile phone	You may have accidentally chosen NOT ACTIVE in the SIGNAL SETTINGS menu	On the notification settings menu, set VIS. + ACOUST. or VIS. SIGNAL ➔ SMS MESSAGE READER FUNCTIONS — NOTIFICATION SETTINGS

Problem	Probable cause	Possible solution
Some SMS messages on your mobile phone are not displayed in the system's SMS message inbox	The system is capable of reading and saving the last 20 SMS messages received whilst the mobile phone is connected to the system. Messages received in other contexts are not transferred to the system	It is possible to delete the SMS messages saved by the system. ➤ SMS MESSAGE READER FUNCTIONS, paragraphs MANAGING SMS MESSAGES and DELETING ALL SMS MESSAGES
Some SMS messages, or part of them, are not read or are not read correctly by the hands-free system	Some 'special' characters in the received SMS message cannot be interpreted by the system	—
The system's SMS message reader displays the sender's phone number instead of their name	Probably, when registering the phone, it was decided not to download the phonebook, or if your mobile phone supports only the management of individual contacts, it was decided to download only some contacts	To download your mobile's phonebook, refer to the appropriate item in the settings menu ➤ SETTINGS FUNCTIONS — REGISTERING YOUR MOBILE PHONE and MANAGING USER DATA paragraphs
Sometimes it is not possible to call the sender of the SMS message received	Some SMS messages, for example those sent from a service provider, do not have the sender's number associated with them, therefore the CALL option cannot be used	—



MEDIA PLAYER

Problem	Probable cause	Possible solution
<p>The display shows: NO FILE</p> <p>Or, the system says: “No multimedia file found”</p>	<ul style="list-style-type: none"> ○ No USB device is connected to the car’s USB port. ○ No digital audio file is present on the USB storage device ○ If there is a break in the power supply, for example if the car battery is disconnected, the system loses power temporarily and the multimedia library must be recreated ○ Your USB storage device is not supported by the system 	<ul style="list-style-type: none"> ○ Follow the instructions to connect your UBS device to the system. ○ Put the digital audio files onto your USB storage device by following the instructions in your software for managing multimedia files. ○ Remove the USB device from the USB port in the car and reinsert it. When it is inserted again, the multimedia library will be recreated. ○ To be compatible with the system, a USB device must be classified as a USB mass storage device.
<p>After having inserted a USB device and turned the ignition key to MAR, no music is heard</p>	<p>Creating the multimedia library may take several minutes</p>	<p>Wait for the library to be created.</p> <p>If the creation of the library takes too long, you can decide to reduce the number of digital audio files on your USB device.</p>
<p>After having inserted a USB device and turned the ignition key to MAR, there are system malfunctions (e.g. failure to play music tracks or no voice messages)</p>	<p>You may have used a USB device with its PASSWORD function on</p>	<p>Disable this function on the USB device</p>

Problem	Probable cause	Possible solution
The display shows: NO PLAYLISTS or the system says: “No playlists found”	You have attempted to play a playlist, but there are none on the connected USB device. The playlist is damaged or invalid	Create a playlist on your computer using your multimedia file management software, and add it to your USB device
The display shows: INVALID		<ul style="list-style-type: none"> ○ Make sure that the playlist is in <i>.m3u</i> or <i>.wpl</i> format. ○ Create the playlist again by following the instructions in the chapter CREATING A PLAYLIST FOR THE SYSTEM in SUGGESTIONS ○ If the problem persists, delete the playlist from your USB device.
The display shows: EMPTY PLAYLIST or the system says: “Empty playlist.”	<ul style="list-style-type: none"> ○ The playlist does not contain multimedia files ○ The <i>.wpl</i> file is too large for the system’s memory ○ The playlist does not contain multimedia file references that are found on your USB device 	<ul style="list-style-type: none"> ○ Delete the playlist from your USB device or insert the multimedia files in the playlist by using your multimedia file management software. ○ You can reduce the number of songs in the playlist by using your multimedia file management software.
Display shows: BAD MEDIA	The digital audio is damaged or invalid	If the digital audio is damaged, delete it from your USB device
Indication on the radio RADIONAV display: MEDIA PLAYER lacks USB device connected to USB port on car	The USB device has been removed from the USB port on the vehicle when the ignition key was turned to STOP	<ul style="list-style-type: none"> ○ Press the SRC/OK button or the FM, AM buttons on the front of the RADIONAV to change the active audio source. ○ As long as the ignition key is in the MAR position, insert and then remove the USB device from the USB port in the car. ○ To avoid the MEDIA PLAYER without USB device message, we suggest you always extract the device with the ignition key turned to MAR, or you stop playing (with the voice command STOP) before you remove the USB device from the vehicle’s USB port.



Problem	Probable cause	Possible solution
<p>The display shows: PROTECTED Or the system says: 'Protected content'.</p>	<p>The audio track that you have chosen to listen to is protected by DRM and cannot be played by the multimedia player</p>	<p>—</p>
<p>The system does not play all the digital audio files in a playlist</p>	<p>Your playlist probably contains files protected by DRM, which are therefore not played, or it contains invalid multimedia file references</p>	<p>For more information see the COMPATIBLE USB STORAGE DEVICES section</p>
<p>The multimedia library does not display all the digital audio files that are on my USB device</p>	<ul style="list-style-type: none"> ○ Your collection of music tracks contains files protected by DRM, which are skipped when playing ○ Your collection of music tracks contains more than 2,000 songs, which is the maximum amount of files that can be imported into the library ○ Your collection of music tracks found on the USB device includes files embedded more than 20 folders deep. The digital audio files in these embedded folders will not be imported into the library. 	<p>—</p>
<p>After you give a command, the system says: "Command not available", even if it is a level 1 voice command</p>	<p>Some commands are not available while the track is paused or while a CD is playing</p>	<p>—</p>

Problem	Probable cause	Possible solution
<p>A USB storage device previously inserted needs more than 10 seconds to play through the system</p>	<p>The USB storage device was removed from your PC before it was ready</p>	<p>To re-establish the USB storage device in Microsoft® Windows® XP, click on MY COMPUTER in the START menu, right click on the USB storage device, go to PROPERTIES and then TOOLS, click on "Scan Disk" in the "Error check" area, select "Automatically correct file system errors" and click START.</p> <p>To avoid this problem in the future, remove the USB device by using the "Safely remove hardware" option.</p>



iPod

Problem	Probable cause	Possible solution
iPod does not work	<ul style="list-style-type: none"> ○ The iPod may have been updated with software that is not compatible with Windows Mobile™ (Blue&Me™ was developed in partnership with Microsoft and is therefore compatible only with systems that support Windows Mobile™) ○ The iPod has not been configured as an external disk ○ It has been enabled for use as an external disk, but it contains tracks in MP4 format (this format is not supported by Blue&Me™) ○ The iPod cannot be configured as an external disk (e.g. iPod Touch, etc.) 	<ul style="list-style-type: none"> ○ Use an alternative USB pen drive or reset the iPod for the Windows environment ○ Enable usage as an external disk (this function cannot be selected with iPod Touch and iPhone) ○ Modify the track format to one that is compatible with Blue&Me™ ○ Use the Blue&Me™ Media Player adapter available from Lineaccessori Alfa Romeo
Audio files do not play from iPhones	<ul style="list-style-type: none"> ○ iPhones cannot be configured as an external disk 	<ul style="list-style-type: none"> ○ Use the Blue&Me™ Media Player adapter available from Lineaccessori Alfa Romeo

Problem	Probable cause	Possible solution
With an iPod or USB memory stick, the system continues playing the same track and you need to press the “forward” button to move onto the next track	The repeat single track function may have been activated inadvertently	The menu contains a specific item, such as “Track loop” or “Repeat track”, which must be disabled. To deactivate: <ul style="list-style-type: none"><input type="radio"/> press the controls activation button on the steering wheel<input type="radio"/> when prompted by the system, say clearly “LOOP OFF”<input type="radio"/> wait for voice confirmation from the system, which will say “TRACK LOOP OFF”
The iPod connected to Blue&Me™ has run out of battery life	When the ignition key is turned to MAR, the vehicle recharges the iPod device unless the iPod’s battery is completely flat	Remember that your iPod must have some charge, or wait a few minutes until the system recharges it



The functions provided by the device include the handling of personal data. To avoid unauthorised access to such information, the device was created in such a way that:

- ❑ Personal data linked to the operation of the hands-free system (contacts and call log) are accessible only after automatic recognition of the user's mobile phone via **Bluetooth®**.
- ❑ The personal data on your device can be deleted by using the dedicated system functions.
- ➔ For further information on deleting personal details, refer to the SETTINGS — MANAGING USER DATA section.

IMPORTANT If you leave your car at a service centre, bear in mind that personal data saved in the system (phonebook and call log) can be detected or subject to improper usage. Before leaving your car at a service centre, you can delete all the registered user data and the phonebook saved on the system.

- ➔ For further information on deleting user data and contacts, please refer to the SETTINGS — MANAGING USER DATA section.

page intentionally left blank



This system contains software licensed by Fiat Auto S.p.A. pursuant to a license agreement. Any removal, reproduction, reverse engineering, or other unauthorised use of the software for this system in violation of the licence is strictly prohibited.

IMPORTANT Tampering inside the device or installing unauthorised software can lead to the cancelling of the warranty and adversely affect the security of the information stored.

END-USER LICENCE AGREEMENT FOR THE USE OF THE SOFTWARE (“EULA”)

- You have purchased a system (“SYSTEM”) containing software supplied under licence by Fiat Auto S.p.A. on behalf of one or more software licensors (“Software Suppliers of Fiat Auto S.p.A.”). Such software products, as for the multimedia elements, printed materials and online or electronic documentation (“SOFTWARE”) are protected by rights and international treaties on the protection of intellectual property. The SOFTWARE is licensed, not sold. All rights reserved.
- **IF YOU DO NOT ACCEPT THIS END-USER LICENCE AGREEMENT (“EULA”), YOU ARE REQUESTED NOT TO USE THE SYSTEM AND NOT TO COPY THE SOFTWARE. INSTEAD, WE ASK YOU TO CONTACT FIAT AUTO S.p.A. AS SOON AS POSSIBLE ABOUT RETURNING THE UNUSED SYSTEM. ANY USE OF THE SOFTWARE, INCLUDING, BUT NOT ONLY, THE USE OF THE SYSTEM, CONSTITUTES YOUR ACCEPTANCE OF THIS EULA (OR THE RATIFICATION OF ANY PREVIOUSLY AGREED CONSENT).**

GRANTING OF THE SOFTWARE LICENCE. This EULA grants you the following licence:

- You can use the SOFTWARE as installed on the SYSTEM.

DESCRIPTION OF OTHER RIGHTS AND LIMITATIONS

- **Voice recognition.** If the SOFTWARE contains one or more components with voice recognition, bear in mind that voice recognition is an intrinsically statistical process and that errors in voice recognition are part of the process itself. Neither Fiat Auto S.p.A. nor its suppliers will be liable for any damage resulting from errors in the voice recognition process.
- **Restrictions on Reverse Engineering, Decompilation and Dismantling.** You are not authorised to operate the reserve engineering of the SOFTWARE, nor decompile it or dismantle it, except as expressly permitted by applicable law notwithstanding this limitation.

- **Single EULA.** The documentation relating to this SYSTEM and intended for the final user can contain multiple versions of this EULA, such as for example several translations and/or several multimedia versions (or in the documentation and in the software). Even if you receive several versions of the EULA, your user licence will apply to only one (1) copy of the SOFTWARE.
- **Software transfer prohibition.** You may not rent, transfer or loan the SOFTWARE without authorisation from Fiat Auto S.p.A.
- **SOFTWARE transfer.** Pursuant to this EULA, you can definitively transfer all your rights only and exclusively by selling or transferring the SYSTEM, provided you do not retain any copies, and transfer the entire software (including all its components, the printed and electronic material and any updates, this EULA and, if applicable, the Certificate(s) of Authenticity), and if the recipient accepts the terms of this EULA. If the SOFTWARE is an update, the transfer must include all the previous versions of the SOFTWARE.
- **Cancellation.** Without prejudice to each other's right, Fiat Auto S.p.A. or the Software Suppliers to Fiat Auto S.p.A. can terminate the EULA if you do not respect the terms and conditions contained therein. In this case, you will have to destroy all copies of the SOFTWARE and all its components.
- **Data usage consent.** You consent to the Software Suppliers to Fiat Auto S.p.A., their related companies and/or their appointed representative obtaining and using technical information collected by them in any manner within the framework of the assistance services for the SOFTWARE. The Software Suppliers of Fiat Auto S.p.A., their related companies and/or their appointed representative may use such information only in order to improve their products or to provide you with personalised services or technology. The Software Suppliers of Fiat Auto S.p.A., their related companies and/or their appointed representative may reveal this information to others, but not in such a way that you can be identified.
- **Internet-based services components.** The SOFTWARE may contain components that allow and facilitate the use of services based on the Internet. You are aware of and agree that the Software Suppliers of Fiat Auto S.p.A., their related companies and/or their appointed representative may automatically check the version of the SOFTWARE used by you, and/or its components, and may provide updates or supplements to the SOFTWARE, which may or may not be automatically downloaded to your SYSTEM.
- **Software/Additional Services.** The SOFTWARE may allow Fiat Auto S.p.A., the Fiat Auto S.p.A. Software Suppliers, their associated companies and/or their designated representatives to supply them with or make available updates, supplements, complements or components based on the Internet for their SOFTWARE after the date on which you obtain the first copy of the SOFTWARE ("Supplementary Components").



- If Fiat Auto S.p.A. supplies or makes available Supplementary Components and no other EULA is provided with them, then the terms of this EULA will be valid.
- If Software Suppliers of Fiat Auto S.p.A., their related companies and/or their appointed representative make available to you Supplementary Components, without providing any other EULA conditions, the terms of this EULA will apply, except for the fact that the Software Suppliers of Fiat Auto S.p.A., or their subsidiary that provides the Supplementary Component(s) will be considered as the licensor for the Supplementary Component(s).
- Fiat Auto S.p.A., the Software Suppliers of Fiat Auto S.p.A., their related companies and/or their appointed representative reserve the right to terminate any internet-based service provided to you or made available to you through the use of the SOFTWARE.
- **Connection to Third-party sites.** The SOFTWARE may give you the possibility, through the use of the SOFTWARE, to access the sites of third parties. The third-party sites do not fall within the framework of control of the Software Suppliers of Fiat Auto S.p.A., their related companies and/or their appointed representative. Neither the Software Suppliers of Fiat Auto S.p.A. nor their related companies or their appointed representative shall be responsible for (i) the content of any third-party websites, any links contained in such sites, or any changes or updates to third-party sites, or for (ii) broadcasts via the internet or any other type received from any third party. If the SOFTWARE provides links to third-party websites, such links are made available only for your convenience: the inclusion of a link does not imply approval of the third-party website by Software Suppliers of Fiat Auto S.p.A., their related companies and/or their appointed representative.

SUPPORTS FOR UPDATES AND RENEWAL

- If the SOFTWARE is provided by Fiat Auto S.p.A., separately from the SYSTEM, on media such as ROM chip, CD ROM or with downloads from the Internet or by other means, and if it is labelled 'Only For Update', you can install one (1) copy of the SOFTWARE on the SYSTEM, to replace the existing software, and you can use it in accordance with this EULA, including any additional terms for the EULA annexed to the SOFTWARE update.

INTELLECTUAL PROPERTY RIGHTS

All the intellectual property titles and rights to the SOFTWARE (including, but not only, images, photographs, animations, video files, audio files, music, texts and applets, built into the SOFTWARE), the relevant printed material and any copy of the SOFTWARE are the property of the Software Suppliers of Fiat Auto S.p.A., their related companies or suppliers. The SOFTWARE is licensed, not sold. Copying the printed material attached to the SOFTWARE is not permitted. All the intellectual property titles and rights on the content to which the SOFTWARE gives access are the property of the respective owners of the content, and are protected by laws and treaties

applicable to reproduction rights and intellectual property. This EULA does not give you any right to use such content. All rights not expressly provided with this EULA are kept by the Software Suppliers of Fiat Auto S.p.A., their related companies and suppliers. The use of any online service to which the SOFTWARE gives access will be regulated by the usage terms for these services. If this SOFTWARE contains documentation provided only in electronic form, you may print a copy of such documentation.

EXPORT RESTRICTIONS

You agree that the SOFTWARE is subject to the jurisdiction on exports of the US and the European Union. You undertake to respect all national and international laws applicable to the SOFTWARE, including US Export Administration Regulations and the restrictions for the end user, the end use and the destination issued by the US and other governments.

- **TRADEMARKS.** This EULA does not grant you any rights in connection with any trademarks or service marks of the Software Suppliers of Fiat Auto S.p.A., their associated companies or suppliers.
- **PRODUCT SUPPORT.** Product support for the SOFTWARE is not provided by the Software Suppliers to Fiat Auto S.p.A. or their related companies or subsidiaries. For product assistance, we ask you to refer to the entities suggested by Fiat Auto S.p.A. and indicated in the SYSTEM manual. For any questions concerning this EULA, or if you want to contact Fiat Auto S.p.A. for any other reason, please refer to the suggestions indicated in the SYSTEM documentation.
- **Exemption of Responsibility for Certain Damage.** EXCEPT WHERE PROHIBITED BY LAW, THE SOFTWARE SUPPLIERS TO FIAT AUTO S.p.A. AND THEIR SUBSIDIARIES WILL NOT BE LIABLE FOR ANY INDIRECT, SPECIAL, NON-CONTRACTUAL OR UNEXPECTED DAMAGE ARISING FROM OR RELATED TO THE USE OR MANAGEMENT OF THE SOFTWARE. THIS RESTRICTION WILL ALSO APPLY IN THE EVENT THAT ANY REMEDY FAILS IN ITS MAIN INTENTION. UNDER NO CIRCUMSTANCES WILL THE SOFTWARE SUPPLIERS OF FIAT AUTO S.p.A. AND/OR THEIR SUBSIDIARIES BE LIABLE FOR SUMS EXCEEDING TWO HUNDRED AND FIFTY US DOLLARS (250.00 USD).
- **FOR ANY LIMITED WARRANTIES APPLICABLE AND SPECIAL REGULATIONS ON JURISDICTION, PLEASE REFER TO YOUR WARRANTY HANDBOOK WHICH IS INCLUDED IN THIS PACKAGE OR HAS BEEN SUPPLIED WITH THE SOFTWARE PRINTED MATTER.**



GENERAL INFORMATION	5	Voice commands	23
Hands free	5	Display	26
SMS message reader	7	Audio	27
Media Player	8	System functions menu	27
Road safety	9	RADIONAV functions menu	28
DISPLAY AND STEERING WHEEL CONTROLS ...	11	HANDS-FREE FUNCTIONS	29
 		Making a call	29
QUICK GUIDE TO HANDS-FREE FUNCTION	15	Managing an incoming call	33
Preparing your mobile phone contacts	15	Managing an ongoing call	33
Getting to know the voice commands	16	Teleconference function	34
Registering your mobile phone	16	 	
Making a call	17	SMS MESSAGE READER FUNCTIONS	35
 		Reading last message received	35
QUICK GUIDE TO SMS MESSAGE READER	19	Inbox	36
 		Managing SMS messages	36
QUICK GUIDE TO THE MEDIA PLAYER	21	Deleting all messages	37
 		Notification settings	37
USING THE SYSTEM	23	 	
Steering wheel controls	23	MEDIA PLAYER FUNCTIONS	39
RADIONAV controls	23	Connecting a USB device to the system	39

Managing the multimedia library	39	Suggestions for using the Media Player	45
– Selecting a folder	40	– Scrolling	45
– Selecting an artist	40	– Organising multimedia files	46
– Selecting a musical genre	41	– Creating the multimedia library	46
– Selecting an album	41	– Creating a playlist	46
– Selecting a playlist	42	SETTINGS FUNCTIONS	47
Listening to audio tracks	42	Privacy function management	47
– Shuffling the entire multimedia library	42	Managing user data	47
– Playing audio	42	Registering a mobile phone	50
– Pause	43	Advanced options	53
– Resume	43	– Accessing the system code	53
– Next track	43	– Changing the GPRS connection code	54
– Previous track	43	Exiting the Settings menu	54
– Change audio source	43	TECHNOLOGIES COMPATIBLE WITH	
Media Player settings	44	Blue&Me™	55
– Autoplay	44	Mobile phones with Bluetooth®	55
– Shuffle	45	– Mobile phones with phonebook management	55
– Track loop	45	– Mobile phones with management of single contacts	55



- Mobile phones with SMS message management 55
- Compatible USB storage devices 56
- USB storage devices 56
- Managing audio files from iPods 56
- Compatible digital audio files 57
- Compatible playlist formats 58

LIST OF AVAILABLE VOICE COMMANDS 59

- Table of permanently available voice commands 59
- Table of hands-free voice commands 60
- Table of SMS message reader voice commands 62
- Table of voice commands for settings functions 63

TROUBLESHOOTING 65

- Hands free 65
- General problems 65
- SMS message reader 73
- Media Player 75
- iPod 79

DATA PROTECTION 81

WARNINGS FOR THE USE OF SYSTEM SOFTWARE 83





SERVICE

CUSTOMER SERVICES

TECHNICAL SERVICES — SERVICE ENGINEERING

Largo Senatore G. Agnelli. 5 -10040 Volvera — Torino (Italia)

Fiat Group Automobiles S.p.A.

Print No. 604.38.244 — 1 Edition — 10/2009

Copyright. Reproduction, even partial, without written authorisation from Fiat Group Automobiles S.p.A. is prohibited.

ENGLISH

Alfa Services

